

USE AND INSTALLATION HANDBOOK

Xtreme



INDEX OF TOPICS

1. Warnings	pag. 3
2. Overview	3
3. Handling	4
4. General description	4
5. Installation	5
6. Light indications and buttons	6
7. Displays	7
8. General operation	10
9. Parameter setting	10
10. General settings	11
11. Settings pump	21
12. Operating programs	27
13. Gsm modem setting	31
14. Alarm setting	34
15. Restore settings	37
16. Alarm list	38
17. Electric connections	39
18. Application examples	44
19. Stop of the pump	49
20. Maintenance	49
21. Waste disposal	49
22. Spare parts	49
23. Conformity declaration	50
24. General conditions of sale	51

1. WARNINGS

The following symbols, accompanied by the words: "DANGER", "WARNING", indicate the potential hazard resulting from failure to observe the associated warning, as specified below:



DANGER
RISK OF ELECTRIC
SHOCK

Failure to observe this warning may result in electric shock



DANGER

Failure to observe this warning may cause personal injury and/or damage to property



WARNING

Failure to observe this warning may cause damage to the pump, the unit or the system

- CAUTION:

Make sure the pumps are fully primed before you start them.

- CAUTION:

Ensure the correct direction of rotation of the pumps.

- CAUTION:

The control panel must be connected by a qualified electrician in compliance with the electrical regulations in force.

- CAUTION:

The electric pump or the motor and the panel must be connected to an efficient grounding system in compliance with the electrical regulations locally in force.

- CAUTION:

Ground the unit before carrying out any other operation.

- CAUTION:

The electric pump or the motor can start up automatically.

- CAUTION:

As a general rule, always disconnect the power supply before proceeding to carry out any operation on the electrical or mechanical components of the unit or system. If you must work inside the electrical panel is also necessary to disconnect the internal battery (installed simultaneously with GSM module).

2. OVERVIEW

The purpose of this manual is to provide the necessary information for the proper installation, use and maintenance of XTREME¹. The user should read this manual before operating the unit. Improper use may cause damage to the machine and lead to the forfeiture of the warranty coverage. Always specify the model identification code and the construction number when requesting technical information or spare parts from our Sales and Service department. The instruction and warnings given below concern the standard version; refer to the sale contract documentation for modifications and special version characteristics. For instructions, situations and events not considered in this manual or in the sale documents, please contact our customer service.

Our units must be installed in sheltered, well-ventilated, non-hazardous environments and must be used at a maximum temperature of +40°C and minimum of -5°C (relative umidity 50% at 40°C not condensed).

3. HANDLING



The panel must be handled with care, as falls and knocks can cause damage without any visible external signs.

If for any reason the unit is not installed and started immediately after it has reached its destination it must be stored properly. The external packaging and the separately packed accessories must remain intact, and the whole must be protected from the weather, especially from freezing temperatures, and from any knocks or falls.

PRELIMINARY INSPECTION: after you have removed the external packaging, visually inspect the control panel to make sure it has suffered no damage during shipping.

If any damage is visible, inform our dealer as soon as possible, no later than five days from the delivery date.

4. GENERAL DESCRIPTION



XTREME⁴ is an electronic panel for direct start-up of 1 single or three phase pump with dry running protection via $\cos\phi$ and minimum current, remote management with gsm and app.

FOURGROUP S.r.l. shall not be liable for any damage caused or suffered by the unit as a result of its unauthorised or improper use.

GENERAL FEATURES

multi language; password; mains supply return delay; motor self-test; protections delay; 50-60Hz frequency; various start-up alternations; simultaneous motor operation; motor exclusion; start delay; settings via GSM-APP.

GENERAL SETTINGS

self-learning of motor data; min-max current (A); min $\cos\phi$; tart delay setting; stop delay setting; max continuous operation; max start-ups per hours; max start-ups per minute; max klixon trips; service request.

DISPLAY VIEWS

voltage (V); frequency (Hz); motor absorption(A); motors $\cos\phi$; pulsecounter; running hours; presence of GSM; pressure (bar); water level (mt); last alarms; service request.

ALARMS, ALARMS OUTPUT AND PROTECTIONS

acoustic alarm mode; luminous alarm mode; alarms via relay; 12V alarm output; alarm delay; alarm activation distinction; min-max water level; min-max voltage; phase error; frequency error; min-max motor current; min motors $\cos\phi$; motors klixon trip; max klixon trips; water in oil chamber; max start-ups per hours; max start-ups per minute; max continuous operation

DEFAULT OPERATING MODES

CLEAN

min level probe or float switch input; pressure switch or float switch inputs; emptying-filling mode; 4-20mA sensor if present: > level-pressure views on display, > pressure-level alarm setting on display.

DARK

float switch inputs (normal or multi-contact types); max level float switch input; self-holding; emptying-filling mode; 4-20mA sensor if present: > level-pressure views on display, > pressure-level alarm setting on display.

DIGIT

min level probe or float switch input; 4÷20mA pressure-level probe input; motor start-up pressure-level setting; motor stop pressure-level setting; motor stop pressure-level setting.

PAUSE/WORK

program allows managing the operation of the pump only with two defined timing, independent of the inputs, the pause (downtime pump) and work (pump start-up time).

5. INSTALLATION



Fix the control panel for a stable support with screws and screw anchor using the holes arranged in the box (fig. 1) or the fixing bracket if present.

To fix the cables in their terminals use a tool of the proper size to avoid the damaging of the screws or of their seat. If use an electric screwdriver pay attention not to spoil the thread or the screws.

After the fixing, remove every plastic or metallic surplus (ex. Pieces of copper of the cables or plastic shavings of the box) inside the box before supplying power.

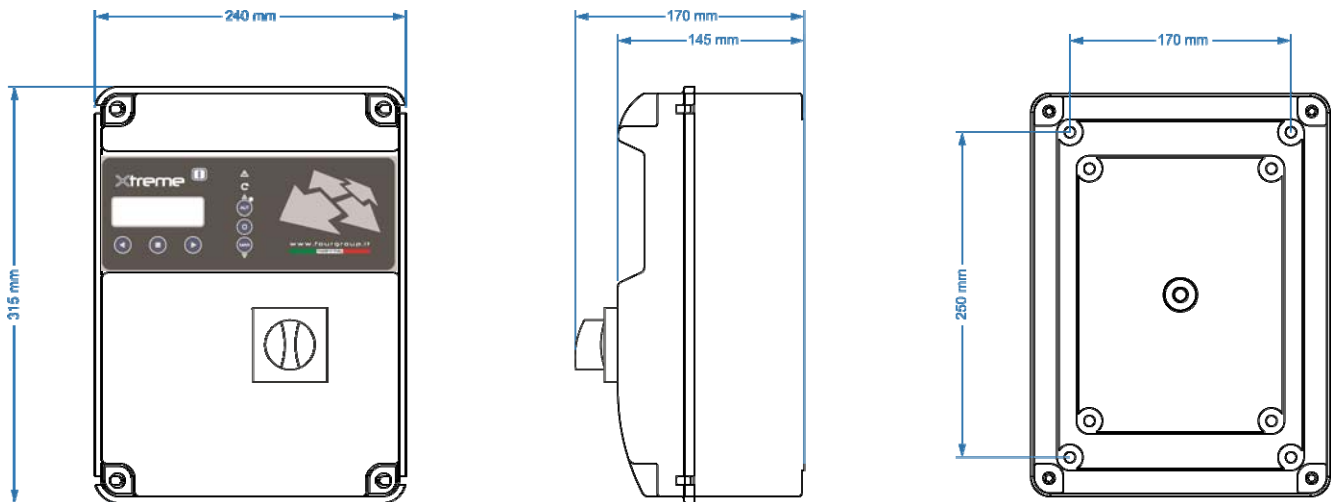

Fig.1

ATTENTION: the display / sinoptic located on the cover of the control panel is connected through one or more cables (even cable type flat) to electronic control unit installed on the bottom of the control panel. Pay utmost attention and care by opening the electric panel. Once opened the control panel, support the cover so as not to damage / tear the connection cables.

NOTE: do not install the control panel close to objects in contact with flammable liquids, water or gas.

Line of supply current

Connect the unit at ground before carrying out any other operation.

The voltage input corresponds to the data written on the panel and on the pump:

(**400V** \pm 10% 50/60Hz x il **XTREME¹-T**)

(**230V** \pm 10% 50/60Hz x il **XTREME¹-T**)

(**230V** \pm 10% 50/60Hz x il **XTREME¹-M**).

Make sure that the power-supply-cable can bear the nominal current and connect it to the terminals of the general switch of the control panel.

If the cables are exposed, they must be appropriately protected.

The line must be protected with a differential magnetotermic switch measured in accordance with the regulations locally in force.

Line of motor power supply

Connect the unit at ground before carrying out any other operation.

The voltage input corresponds to the data written on the motors:

(**400V** \pm 10% 50/60Hz **three-phase**)

(**230V** \pm 10% 50/60Hz **three-phase**)

(**230V** \pm 10% 50/60Hz **single-phase**).

Doing some starting make sure that the motors respect the right direction of rotation usually indicated by an arrow printed on the motors.

6. LIGHT INDICATIONS AND BUTTONS

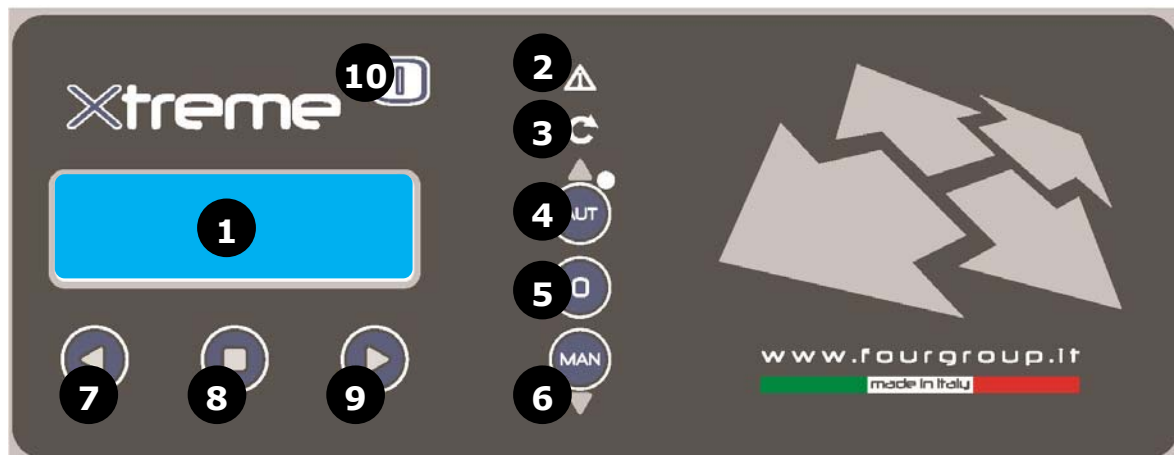

1

DISPLAY backlit blue to display the parameters of the system

2

ALARM red led to indicate an alarm is active; when the red led is on it indicates the presence of an alarm and that made the pump stopped

3

START green led to indicate the pump is currently working. the flashing led indicates it's waiting for the start timer to expire

4

AUT button with three features:
 - activation of automatic pump operation
 (the green LED on indicates that the automatic operation is active)
 - upward / incremental shift in the programming menu
 - if pressed for 4sec it starts the SELF-SET procedure

5

0 button to stop the pump and reset related alarms

6

MAN button with two features:
 - activation of manual pump operation;
 - downward / decremented shift in the programming menu

7

< button to move toward left in the program menu selection

8

ENTER button with three features:
 - enabling modification / saving in the programming menu
 - display change in the operating parameters menu
 - if pressed for 10 seconds it allows the KEY LOCK / UNLOCK

9

> button to move toward right in the program menu selection

10

ON blue led to indicate the voltage is on and the panel is turned on by mains supply

7. DISPLAYS



The overall menu settings are composed of a series of horizontal menus that allows access to sets of horizontal and verticals parameters. As the following flowchart example:

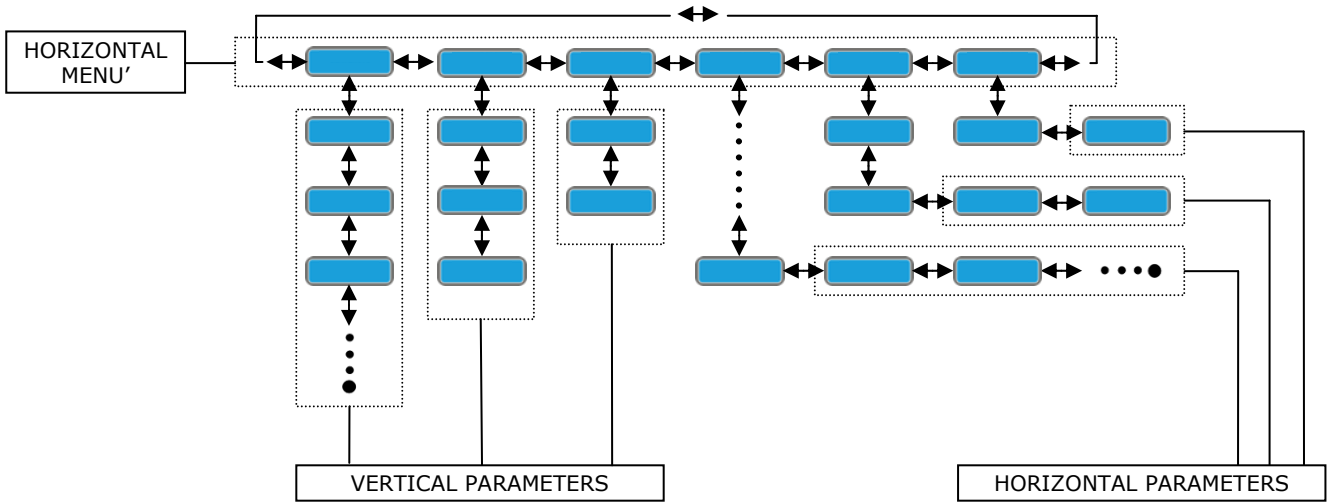

NOTE: on the next page shows the complete flow chart programming

When the panel is turned on the display will light up:

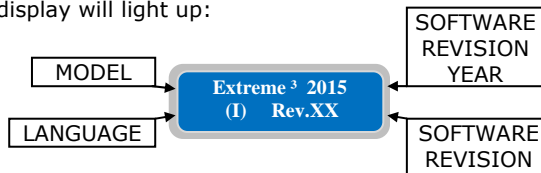

Subsequently the start-up routine will execute:



At the end of the start-up routine the display will show following default main display:

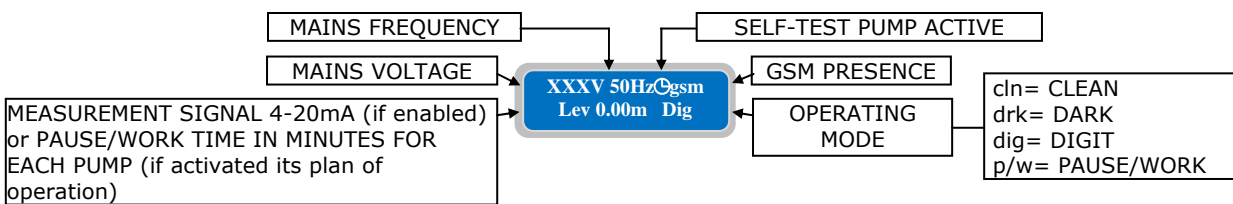

The main default display shows the current working parameters.

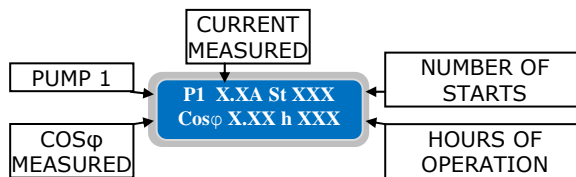

By pressing the button  is possible to move to different screens and show the working parameter of the individual pump

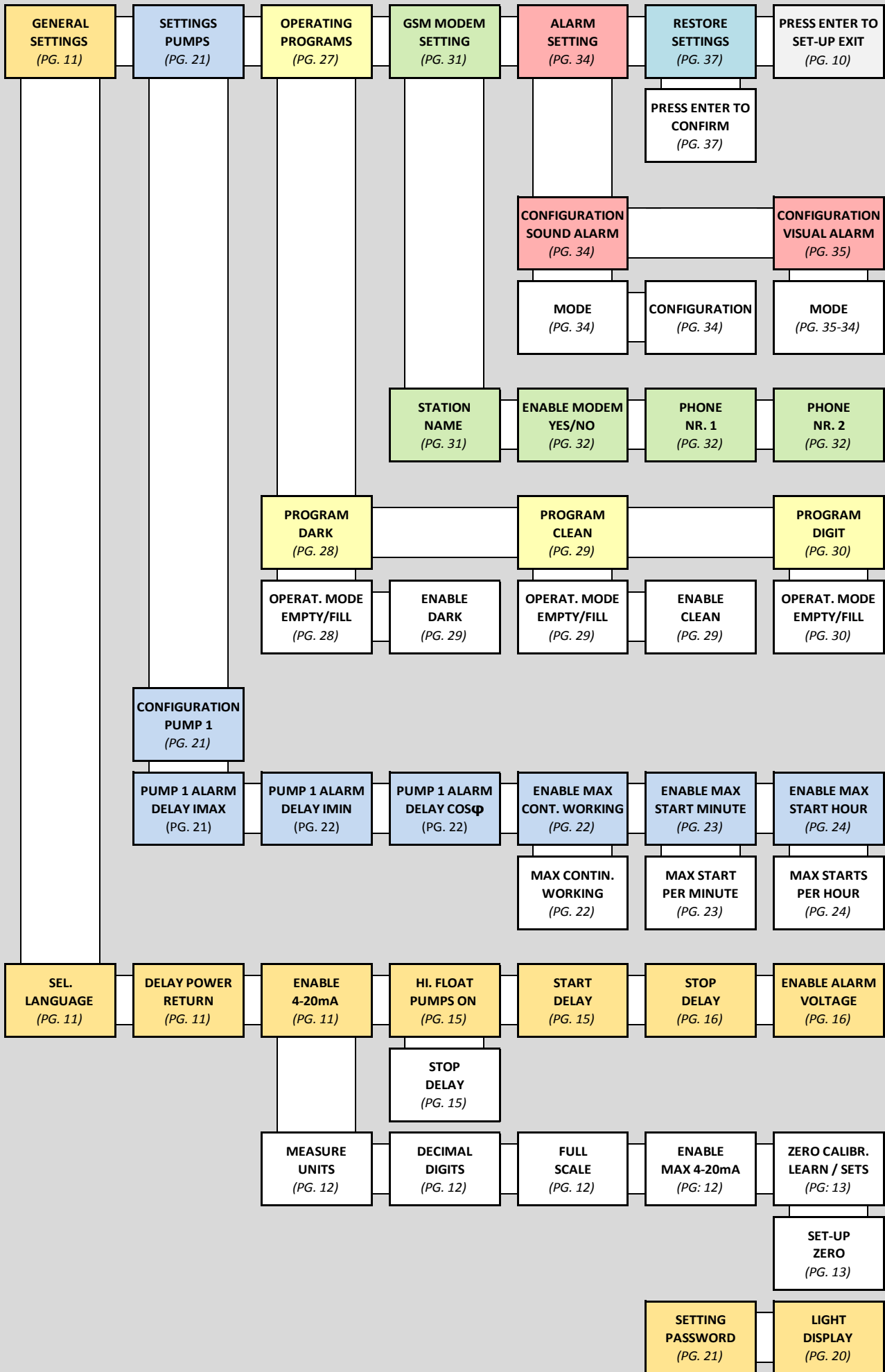

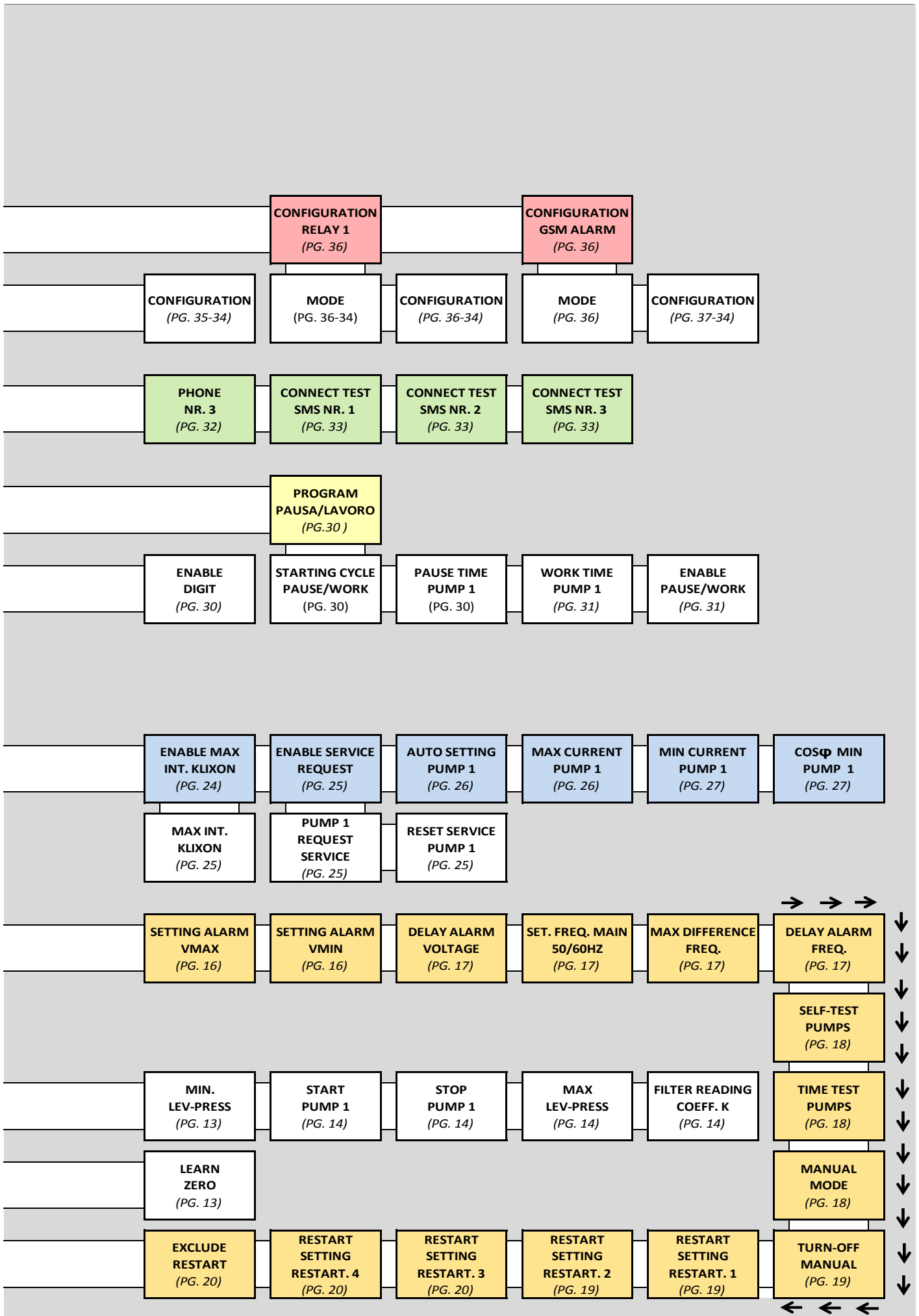





8. GENERAL OPERATION

To modify the parameter settings of operation the user will need to enter the programming mode, then you must pressing simultaneously the two buttons  and  until the display shows the following password screen:



To continue the correct password is required (the default password is 0000) and press the button .

To enter a new password you need to change the parameter "Password Setting" and press the button .

NOTE: When you enter the programming mode the pump stop.

To navigate the menus horizontally using the buttons  , between the vertical parameters keys  .

To exit the programming menu you need to display the following horizontal menu and press .



To quickly return to the main horizontal menu, just press repeatedly the button .

NOTE: The exit from the programming menu without saving happens automatically if you do not press any button for 1 minute.



9. PARAMETER SETTING

To modify a parameter the user needs to enter "programming mode" (explained in details in the next chapter) and then select the desired parameter to be modified:





Pressing the button  will select the digit for modification with a flashing cursor:



The buttons  and  will increase or decrease the value of the parameter;



the buttons  and  will move the cursor to the appropriate digits to allow their settings to be changed (the flashing cursor moves to the digit):



Once the specific parameter is set to the desired value it can be saved by pressing the button . Once the parameter is saved, the display will show briefly the message "save" as confirmation that the setting has been saved.



10. GENERAL SETTINGS

Once entered in the programming mode the first horizontal menu will be:



Pressing and navigate the horizontal menus. With the button displays the corresponding vertical parameter:

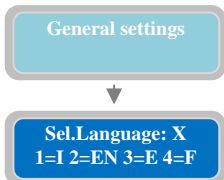

The parameter "Select Language" will set the language selection for the alarm messages to be displayed (the "X" indicates the position of the parameter to modify):
 1=Italian; 2=English; 3=Spanish; 4=French.
 Factory default selection: 1-Italian.

To move to the next horizontal parameter press the button (as indicated in the flow-chart attached to this manual as an example, the menu structure of the horizontal parameter is circular; therefore, by pressing the buttons or the button to display the following parameter; to facilitate the descriptions of the parameters settings the manual will show the navigation inside the various menus:



The parameter "Delay after Power Return" will set the timer delay to wait before reactivating the control panel after a power-cut.
 The "X" indicates the digit of the parameter to modify:
 The settable range value is from 0 to 999 seconds.
 0: setting the value to "0" (0=RND, random) will set the timer delay to a random value automatically (the timer value will be between 1 and 999 seconds) by the control panel at every restart after every power-cut (this function is useful in a station with several control panels XTREME and it's not desired the simultaneous reactivation of several control panels).
 Default setting: 3 seconds.

Note: the delay timer to reactivate of the control panel is displayed as a countdown timer to the restart after power-cut. During the countdown the operating functions are inhibited. Therefore, it's not possible to operate the display/settings also it is not possible to use for programming mode, nor manual operation.

To move to the next horizontal parameter press the button :

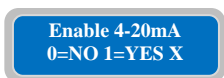
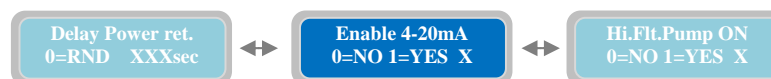

The parameter "Enable 4-20mA" will allow to activate/deactivate the use of the reading device with signal 4-20mA (for example, pressure transducer, piezoresistive sensor, ultrasounds sensor, etc...). The activation of input 4-20mA allows the use of working in operating mode "DIGIT". It is possible to utilize the 4-20mA device even as simple monitor of levels and usage of relative alarms.

The "X" indicates the position of the parameter to modify:
 0=NO: input 4-20mA DISABLE.
 1=YES: input 4-20mA ENABLE.
 Factory default setting: 0 (DISABLE).



Pressing the button will gain access to the set of parameters related to the reading of the input of 4-20mA device:

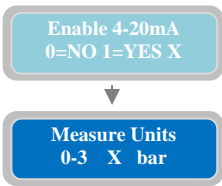

In the parameter "Measure Units" is possible to select the unit of measurement used in the display of the signal 4-20 mA.
Depending on the sensor type used you can choose from:
(The "X" indicates the digit of the parameter to modify)
0=bar used for the pressure transducers in the pressurization system,
1=m (meter) used for piezoresistive sensors of level of liquid recovery systems,
2=l/m (liters per minute) used for flow meters in small water systems,
3=m³/h (cubic meters per hour) used for flow measurement in large water systems,
Default setting: 0 (bar).

To move to the next horizontal parameter press the button :



In parameter "Decimal digits" you can specify the number of decimal places and then the decimal point position in the measure of analogue 4-20mA sensor. This option is useful to be able to interface the board with sensors with different values of full scale.
The "X" indicates the position of the modifiable parameter:
0=NO DECIMAL (the measure will have as maximum 9999),
1=1 DECIMAL (the measure will have as maximum limit 999.9),
2=2 DECIMAL (the measure will have as maximum 99.99),
3=3 DECIMAL (the measure will have as maximum 9.999),
default setting: 2.

To move to the next horizontal parameter press the button :



The parameter "Full Scale" is used to indicate the full scale of the sensor device 4-20 mA being used (bar or meter depending on the mode selected in the previous parameter).
(The "X" indicates the digit of the parameter to modify).
The range of the value is from 0.000 to 9999 (with decimals and units of measurement chosen previously).
Factory default setting: 16.00.

To move to the next horizontal parameter press the button :



The parameter "Enable Max 4-20" is used to start the pump connected, once the maximum level is reached (the actual value of such maximum level of the sensor 4-20 mA is to be set in the following parameters). In the case of "bar" as the selected unit of measurement, the maximum level set is to be intended as maximum pressure.
The "X" indicates the digit of the parameter to modify:
0=NO: DISABLE the start of pump once the maximum level is reached.
1=YES: ENABLE the start of pump once the maximum level is reached.
Factory default setting: 0 (DISABLE).

To move to the next horizontal parameter press the button :



Zero Calibration
Learn / Sets

The parameter "Zero Calibration Learn/Sets" is used to choose whether to have an auto setting or manual setting of the RELATIVE zero of the 4-20mA sensor being used. Therefore, it's possible to set the "zero" not at the actual zero level ("0" meters of level or "0" bar of pressure), but at a different level (for example, 2 meters of level or 1 bar of pressure) to always maintain a gauge.

To proceed with the setting of the calibration for relative zero press the button  :

Zero Calibration
Learn / Sets

The parameter "Learn Zero" will set the value automatically for the relative zero setting. Pressing the button  will set the value automatically as the relative zero of level/pressure at the moment the button is pressed.

Learn
Zero: XX.XX

To manually set the "relative zero" press the button  :

Learn
Zero: XX.XX

Set-up
Zero: XX.XX

Set-up
Zero: XX.XX

The parameter "Set-up Zero" will set the value of the relative zero manually. The "X" indicates the digit of the parameter to modify. The range of value is from 00.00 to 99.99 (bar or meters depending on the choice made previously).
Factory default setting: 00.00.

Pressing the button  it is possible to continue to program all the parameters relative to the 4-20mA device.

Enable Max 4-20
0=NO 1=YES X

Zero Calibration
Learn / Sets

min. Lev-Press
XX.XX

To move to the next horizontal parameter press the button  :

Zero Calibration
Learn / Sets

min. Lev-Press
XX.XX

Start P1
XX.XX

min. Lev-Press
XX.XX

The parameter "Min lev-press" will set the level/pressure (in meter or bar depending on the mode previously selected) for which to trigger an alarm. The alarm of minimum level/pressure will stop the pump and will show in the visual display and, depending on the settings of associated menu, it can activate one or more output relays. (The "X" indicates the digit of the parameter to modify).
The range of value is from 00.00 to 99.99.
Factory default setting: 0.50

To move to the next horizontal parameter press the button  :

min. Lev-Press
XX.XX

Start P1
XX.XX

Stop P1
XX.XX

Start P1 XX.XX

The parameter "Start P1" will set the level/pressure (in meter or bar depending on the mode previously selected for which to start the Pump 1.
This parameter is usable only in the DIGIT and MULTITANK programming mode, in all other programming modes this parameter is inhibited.
(The "X" indicates the digit of the parameter to modify).
The range of value is from 00.00 to 99.99.
Factory default setting: 1.00

To move to the next horizontal parameter press the button  :



Stop P1 XX.XX

The parameter "Stop P1" will set the level/pressure (in meter or bar depending on the mode previously selected for which to stop the Pump 1.
This parameter is usable only in the DIGIT and MULTITANK programming mode, in all other programming modes this parameter is inhibited.
(The "X" indicates the digit of the parameter to modify).
The range of value is from 00.00 to 99.99.
Factory default setting: 2.00

To move to the next horizontal parameter press the button  :



Max Lev-press XX.XX

The parameter "Max Lev-Press" will set the level/pressure (in meter or bar depending on the mode previously selected) for which to trigger an alarm. At the activation of the maximum level/pressure alarm it is possible to start the pump by setting the parameter "Enable Max 4-20mA" (please refer to the section "Enable Max 4-20mA"). In addition to the displayed alarm, depending on the settings of the associated menu, it is possible to activate one or more output relays.
(The "X" indicates the digit of the parameter to modify).
The range of value is from 00.00 to 99.99.
Factory default setting: 10.00

To move to the next horizontal parameter press the button  :



Filter reading Coeff. K: XXX

In parameter "Filter reading" you can increase / decrease the delay of the reading of 4-20 mA signal: setting a low value reading signal will be faster, with a higher value will become slower. Increase this coefficient is particularly useful in cases in which the reading signal (pressure / Level) of the sensor becomes unstable maybe because of rapid changes in pressure / Level.
(The "X" indicates the digit of the parameter to modify).
The range of value is from 0 to 200.
Factory default setting: 50.

At this point the set of parameters associated to the input reading are complete. By pressing the button  it is possible to return to the previous vertical parameter "Enable 4-20mA":

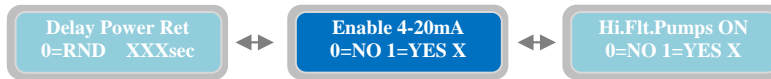

To move to the next horizontal parameter press the button  :





In parameter " Hi.Flt.Pumps ON " you can decide the functionality of the alarm float. The alarm float (or more generally a consensus alarm, that is a dry contact closure at which the alarm is activated) must be physically connected to the XTREME framework (see section "Electric connections").

The "X" indicates the digit of the parameter to modify:

1=YES: the activation of the alarm float you will have the alarm signal and depending on the operating mode selected (see parameters menu "mode of operation") on emptying the start of all pumps available (respecting the parameter "contemporary maximum pump ") while on filling the stop of the pumps.

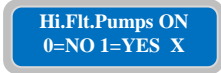
0=NO: the activation of the alarm float switch will cause only trigger the alarm signal.
Factory default setting: 0.



To proceed with the panel operation setting when the alarm float opens, press the key  :

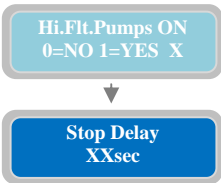

In the parameter "Stop Delay" it is possible to set a delay time for switching off the pumps after the alarm float has been opened. This parameter is effective only with the CLEAN - EMPTY, DIGIT - EMPTY and MULTITANK (with DIGIT - EMPTY program for pump 1) operating programs. It is activated when the previous parameter "Gal. Max. Pumps ON ", is set to 1, ie activated.

(the "X" indicates the position of the modifiable parameter).

The times can be set from 0 to 999 seconds.
Default setting: 1 sec.

Premendo il tasto  è possibile continuare con la programmazione dei parametri del quadro.



To move to the next horizontal parameter press the button  :



The parameter "Start Delay P1" will set a time delay on the re-start of the pump after the starting condition is met; for example, the activation of a start flow switch /pressure switch (for operating modes Dark, Clean) or once we have reached the level of activation for signal 4-20 mA (for operating mode DIGIT). The start of the pump will be delayed accordingly by this set time value (start delay parameter).

The "X" indicates the digit of the parameter to modify.

The range of time delay start is from 4 to 99 seconds.

Factory default setting: 4 seconds.



To move to the next horizontal parameter press the button  :



**Stop Delay
XXsec**

The parameter "Stop Delay" will set a time delay on the stopping of the pump after the stopping condition is met; for example, the opening of a stop flow switch /pressure switch (for operating modes Dark, Clean). Therefore, once the trigger is set for the stopping condition the pump will continue to work for the amount of time set in this parameter.
If during the Stop Delay time a condition for a "minimum level/pressure" is met then the pump will stop (for operating mode CLEAN).
The "X" indicates the digit of the parameter to modify.
The range of time delay start is from 0 to 99 seconds.
Factory default setting: 1 sec

To move to the next horizontal parameter press the button  :



**Enable Alarm Voltage
0=NO X**

With the parameter "Enable Alarm Voltage" it is possible to activate/deactivate the alarm relative to the Mains Power Voltage of the control panel XTREME (Vmax e Vmin). This alarm will:
- Stop all pumps from working
- Display the alarm
- It can activate the output relay alarm (depending on the setting of the associated menu)
The "X" indicates the digit of the parameter to modify.
0=NO: by setting "0" the Voltage alarm is disabled
1=YES: by setting "1" the Voltage alarm is enabled.

To move to the next horizontal parameter press the button  :



**Setting Alarm Vmax
XXX V**

The parameter "Setting Alarm Vmax" will set a voltage threshold over which, if enabled, will trigger the alarm.
The "X" indicates the digit of the parameter to modify.
The range of value is from 400 to 460V for XTREME-T and from 230 to 260V for XTREME-M.
Factory default setting: 440V (XTREME-T); 253V (XTREME-M).

To move to the next horizontal parameter press the button  :



**Setting Alarm Vmin
XXX V**

The parameter "Setting Alarm Vmin" will set a voltage threshold under which, if enabled, will trigger the alarm.
The "X" indicates the digit of the parameter to modify.
The range of value is from 340 to 400V for XTREME-T and from 200 to 230V for XTREME-M.
Factory default setting: 360V (XTREME-T); 207V (XTREME-M)

To move to the next horizontal parameter press the button  :



**Delay alarm voltage
XXsec**

The parameter "Delay Alarm Voltage" will set a delay time on the activation of the voltage's alarm (if previously enabled); the trigger condition (over/under voltage) must persist for the length of time set in this parameter in order to trigger the alarm.
For example, if the Delay Alarm is set to 10 seconds and the trigger condition persists continuously for 10 seconds it will activate the alarm; if the trigger condition persists for less than 10 seconds the alarm will not activate.
The "X" indicates the digit of the parameter to modify.
The range of value is from 0 to 99 seconds.
Factory default setting: 5 sec

To move to the next horizontal parameter press the button  :



**Set Freq. Main
50/60Hz XXHz**

The parameter "Set Frequency Main 50/60 Hz" will set Mains Frequency of the control panel XTREME.
The "X" indicates the digit of the parameter to modify.
The range of value is from 50 to 60 Hz.
Factory default setting: 50Hz.

To move to the next horizontal parameter press the button  :



**Max Difference
Freq. X Hz**

The menu "Max Difference Frequency" will set the value (in Hz) of maximum deviation tolerable from the nominal value of frequency that has been set. The value being set is for both positive and negative deviation; for example, with nominal frequency being set at 50Hz, a deviation of max frequency set to 2Hz will set the tolerable limits between 52Hz (50+2=52) and 48Hz (50-2=48).
The "X" indicates the digit of the parameter to modify.
The range of value is from 1 to 5Hz.
Factory default setting: 2 Hz.
Note: it is not possible to disable the alarm related to the frequency; it's always enable.

To move to the next horizontal parameter press the button  :



**Delay Alarm
Freq. XXsec**



The parameter "Delay Alarm frequency" will set a time delay for the activation of the Frequency alarm (if previously enabled); the trigger condition (over/under frequency) must persist for the length of time set in this parameter in order to have the alarm signal.
For example, if the Delay Alarm is set to 10 seconds and the trigger condition persists continuously for 10 seconds it will activate the alarm; if the trigger condition persists for less than 10 seconds the alarm will not activate.
The "X" indicates the digit of the parameter to modify.
The range of value is from 0 to 99 seconds.
Factory default setting: 2 sec

To move to the next horizontal parameter press the button  :



Self-Test pumps
0=NO XXX h

In parameter "Self-Test pumps" is possible to set the time interval with which the control panel XTREME will perform the periodic self-test operation of the pumps (used to prevent pumps from locking up after long periods of inactivity caused by the conditions installation).

On the screen appears the symbol  indicating the activation of the self-test, or the symbol  until the self-test is in progress. The count begins from the moment the Self is activated then this parameter to change the time once activated it is necessary enter programming mode and

press 2 times the button  on this screen. In case of power failure or warehousing the remaining time it is stored.

The "X" indicates the digit of the parameter to modify

The range of value is from 0 to 999 hours.

0=NO: setting "0" the self-test pumps is disabled.

Factory default setting: 0

To move to the next horizontal parameter press the button  :



Time test Pump
XX sec

The parameter "Time Test Pump" will set the duration of the self-test. In the situation where the self-test is triggered on "minimum level open" (for the operating mode Dark, Clean) or trigger on the level of deactivation from signal 4-20 mA (for operating mode DIGIT), the self-test will last at maximum 3 seconds regardless of the value set in this parameter.

The "X" indicates the digit of the parameter to modify

The range of value is from 0 to 99 seconds.

Factory default setting: 5 seconds.

Note: the self-test will be executed with the following logic:

-start pump; operation for the time being set; stop pump;

To move to the next horizontal parameter press the button  :



Manual Mode
0=INSTABL X

The parameter "MANUAL Mode" will set the operating mode of the buttons "MAN" for the manual operation of the pumps.

The "X" indicates the setting of the parameter to modify

0=UNSTABL: setting "0" the MAN button should be pressed, this indicated "Operator Presence": the pumps will work while the button MAN is being pushed; when the button is released the pumps will stop.

Setting "1" the operation of the pumps will continue for a programmable time (next parameter "Turn-off MANUAL") even after the release of the MAN button. When the timer elapses the pumps will stop.

Factory default setting: 0.

Note: when using the mode "Operator Presence" the operation of the pumps will bypass the protections that have been set (it is therefore necessary to verify that the manual operation will not damage the pumps). On the other hand, the operation mode "Turn-Off MANUAL" is subject to the protection settings.

To move to the next horizontal parameter press the button  :



Turn-Off MANUAL
0=ON XXXsec

The parameter "Turn-off MANUAL" will set the operating time of the pumps after the button MAN has been pressed (only if the "MANUAL Mode" has been set to "1"). Shutdown requires pressing the button 0. The "X" indicates the setting of the parameter to modify. The range of value is from 0 to 999 seconds. Factory default setting: 5 seconds. Note: if it is set to "0" the operating mode will be "at continuous/infinite time" (the "Turn-Off MANUAL" operating mode is subject to the protection settings).

To move to the next horizontal parameter press the button  :



Restart Setting
Restart1 XXX min

The parameter "Restart Setting, Restart 1" related to the Dry Running alarm (the alarm of Dry Running is always enabled and it will trigger when it measures an operating $\cos\phi$ smaller than the minimum $\cos\phi$ being set (parameter " $\cos\phi$ min pump" under the horizontal parameter "Pump parameters") or a pump current consumption smaller than the value of the minimum current (parameter "Min Current pump" set in the horizontal menu "Pump parameters"). It is possible to set the delay timer for the automatic restart after the alarm for dry running condition. The delay time value being set is valid for all the pumps installed. The "X" indicates the setting of the parameter to modify. The range of value is from 1 to 999 minutes. Factory default setting: 5 minutes. Note: every time there is a dry running condition alarm there will be a corresponding alarm output (one or more alarms based on the current setting refer to menu "Alarm settings").

To move to the next horizontal parameter press the button  :



Restart Setting
Restart2 XXX min

The parameter "Restart Setting, Restart 2", as previous parameter, is related to the Dry Running alarm. It is possible to set the timer delay for the automatic restart after the first timer delay alarm for Dry Running condition. If the alarm for Dry condition is still detected after the first restart of the pump the pump will be restarted again after restart timer 2. The time delay value being set is valid for all the pumps installed. The "X" indicates the setting of the parameter to modify. The range of value is from 1 to 999 minutes and it's independent from restart time 1. Factory default setting: 30 minutes.

To move to the next horizontal parameter press the button  :



**Restart Setting
Restart3 XXX min**

The parameter "Restart Setting, Restart 3", as previous 2 parameters, is related to the dry running alarm. It is possible to set the timer delay for the automatic restart after the third Dry running alarm. If the alarm for Dry condition is still detected after the first and second restart of the pump the pump will be restarted again using the time setting of restart setting, "Restart 3". The delay time value being set is valid for all the pumps installed. The "X" indicates the setting of the parameter to modify. The range of value is from 1 to 999 minutes and it's independent from restart time 2. Factory default setting: 60 minutes.

To move to the next horizontal parameter press the button  :



**Restart Setting
Restart4 XXX min**

The parameter "Restart Setting, Restart 4", as previous 3 parameters, is related to the dry running alarm. It is possible to set the timer delay for the automatic restart after the 4th dry running alarm. If the alarm for Dry condition is still detected after the first three restarts of the pump the pump will be restarted again using the time setting restart setting, restart 4. The delay time value being set is valid for all the pumps installed. The "X" indicates the setting of the parameter to modify. The range of value is from 1 to 999 minutes and it's independent from restart time 3. Factory default setting: 90 minutes.

To move to the next horizontal parameter press the button  :



**Esclus. Ripart.
0=NO 1=SI ->X**



The parameter "Exclude Restart" will set the command for the control panel to continue to make restarts after the 4th one or to stop restarting. 0=NO: setting "0" the control panel will continue to restart the pumps with the 4th timer delay setting (i.e. restart the pumps at intervals equal to the parameter set in the "Restart Setting, Restart 4") infinitely. 1=YES setting "1" after the 4th restart of the pump, if the alarm for dry condition is still active the control panel will stop the operation of the pump (or pumps) and it will wait for the "operator manual reset" (manual operation to control the conditions of the system). The "X" indicates the setting of the parameter to modify. Factory default setting: 0.

To move to the next horizontal parameter press the button  :



**Light Display
Off XXXsec**

The parameter "Light Display Off" will set the amount of time of inactivity before the display will turn off automatically (power saving mode) from the last button pressing. If the display is momentarily off in power saving mode, it will go back on after pressing any button.

Note: pressing of buttons , ,  will not have any effect on the operation of program settings of XTREME¹; however, pressing other buttons could modify the operations of the pumps. The "X" indicates the setting of the parameter to modify. The range of value is from 5 to 250 seconds. Factory default setting: 60 seconds. Note: It is not possible to keep the display always On (maximum 250 seconds after last button pressing).

To move to the next horizontal parameter press the button  :



The parameter "Setting Password" allows the user to set/modify the password to access the programming menu.
The "X" indicates the setting of the parameter to modify.
It's possible to set a password of 4 digits.
Factory default password is "0000".

To return to the first horizontal parameter press the button  :

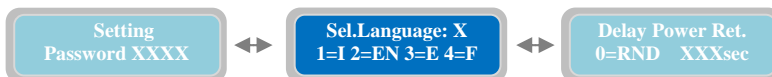

At this point the horizontal menu "General Settings" has been programmed and it is possible to proceed to next menu.

To go back to the horizontal menus press the button  and the "General Settings" menu will be displayed again



Press the button  again to move to the next horizontal menu "Settings Pump"

11. SETTINGS PUMP

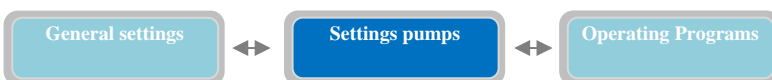

Press the button  to display the underneath vertical parameter:



With the vertical parameter "Configuration pump 1" is possible to set all the parameters relative to pump 1.

From the menu "Configuration Pump 1", pressing the button  will display the following vertical parameter:



The parameter "P1 Alarm Delay I max" will set the time delay for the activation of the alarm for maximum current consumption (overcurrent): the threshold must be crossed (overcurrent) for the amount of time specified for the alarm to trigger and to stop the pump.
For example, if the alarm time delay is set to 10 seconds then the threshold is crossed continuously for 10 seconds for the alarm to activate; if the threshold is crossed for less than 10 seconds alarm will not activate.
The "X" indicates the setting of the parameter to modify.
The range of value is from 5 to 15 seconds.
Factory default setting: 5 seconds.

To move to the next horizontal parameter press the button  :



**P1 Alarm Delay IMin
XXsec**

The parameter "P1 Alarm Delay I min" will set the time delay for the activation of the alarm for minimum current consumption (undercurrent): the threshold must be crossed (undercurrent) for the amount of time specified for the alarm to trigger and to stop the pump.
For example, if the alarm time delay is set to 10 seconds and the threshold is crossed continuously for 10 seconds for the alarm to activate; if the threshold is crossed for less than 10 the alarm will not activate.
The "X" indicates the setting of the parameter to modify.
The range of value is from 1 to 120 seconds.
Factory default setting: 3 seconds.

To move to the next horizontal parameter press the button  :



**P1 Alarm Delay
Cosφ XXsec**

The parameter "P1 Alarm Delay Cosφ" will set the time delay for the activation of the alarm for minimum Cosφ (the lowering of the Cosφ value is an indication that the pump is not sucking water and it's working in dry condition): the threshold must be crossed (dry running condition) for the amount of time specified for the alarm to trigger and to stop the pump.
For example, if the alarm time delay is set to 10 seconds and the threshold is crossed continuously for 10 seconds for the alarm to activate; if the threshold is crossed for less than 10 seconds the alarm will not activate.
The "X" indicates the setting of the parameter to modify.
The range of value is from 1 to 120 seconds.
Factory default setting: 3 seconds.

To move to the next horizontal parameter press the button  :

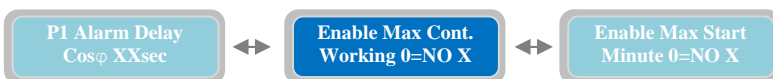



**Enable Max Cont.
Working 0=NO X**

The parameter "Enable Max Continuous working operation" will enable/disable the alarm for the maximum continuous operation of the pump. When enabled and the pump is continuously working for a period of time over the value set then the alarm will be activated and the pump will be stopped. The functional operation of the pump will be inhibited until the reset of the alarm (pressing the button  of the pump in "status of alarm").
The "X" indicates the setting of the parameter to modify.
0=NO: setting "0" will disable the alarm for max continuous working condition of the pump.
1=YES: setting "1" will enable the alarm for max continuous working condition of the pump.
Factory default setting: 0 (disable).

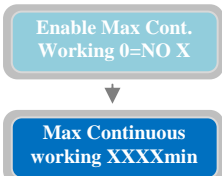
To set the maximum time of continuous operation of the pump is necessary to pass to the parameter "Max Continuous working" by pressing  :



The parameter "Max Continuous working" will set maximum time of continuous working operation of the pump. If the pump works continuously for a period of time longer than the set value then the pump will be stopped and the alarm will trigger. The functional operation of the pump will be inhibited until the reset of the alarm (pressing the button  of the pump in status of alarm).
The "X" indicates the setting of the parameter to modify.
The range of value is from 1 to 9999 minutes.
Factory default setting: 1440 minutes (24hours).

To continue programming the parameters of the pump press the button  to go back to the parameter "Enable Max Cont. working":

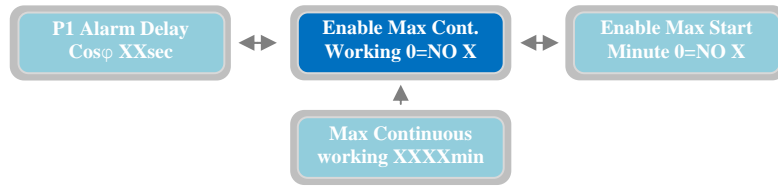

To move to the next horizontal parameter press the button  :

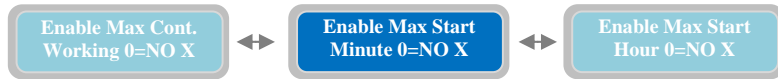

**Enable Max Start
Minute 0=NO X**

The parameter "Enable Max Start Minute" will enable/disable the alarm for the maximum number of starts per minute of the pump. When enabled and the pump executes a number of starts per minute higher than the set value "Max Starts per Minute" the alarm will activate and the pump will stop. The functional operation of the pump will be inhibited until the reset of the alarm. The reset of the alarm will happen automatically at the end of the minute. The "X" indicates the setting of the parameter to modify.
 0=NO: setting "0" will disable the alarm for max number of starts per minute of the pump.
 1=YES: setting "1" will enable the alarm for max number of starts per minute of the pump.
 Factory default setting: 1.

Press the button  to move to the menu for setting the maximum number of starts per minute ("Max Starts per Minute"):

Enable Max Start
Minute 0=NO X

**Max Starts
per Minute X**

The parameter "Max Starts per Minute" will set the pump's maximum number of starts per minute. If the pump executes a number of starts per minute higher than the set value it will be stopped and an alarm will activate. The functional operation of the pump will be inhibited until the reset of the alarm. The reset of the alarm will happen automatically at the end of the minute. The "X" indicates the setting of the parameter to modify.
 The range of value is from 1 to 9.
 Factory default setting: 9.

To continue programming the parameters of the pump press the button  to go back to the parameter "Enable Max Start Minute":

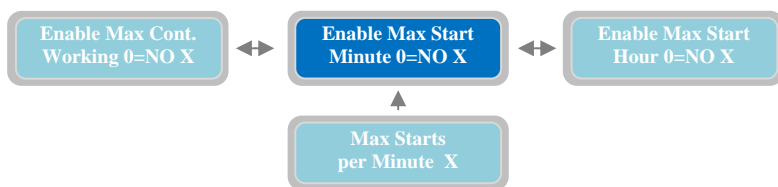

To move to the next horizontal parameter press the button  :



Enable Max Start Hour 0=NO X

The parameter "Enable Max Start Hour" will enable/disable the alarm for the maximum number of starts per hour of the pump. When enabled and the pump executes a number of starts per minute higher than the set value "Max Starts per Hour" the alarm will activate and the pump will stop. The functional operation of the pump will be inhibited until the reset of the alarm. The reset of the alarm will happen automatically at the end of the Hour. The "X" indicates the setting of the parameter to modify.
0=NO: setting "0" will disable the alarm for max number of starts per hour of the pump.
1=YES: setting "1" will enable the alarm for max number of starts per hour of the pump.
Factory default setting: 0 (disable).

Press the button  to move to the menu for setting the maximum number of starts per hour ("Max Starts per Hour"):

Enable Max Start Hour 0=NO X



Max Starts per Hour XX

The parameter "Max Starts per Hour" will set the pump's maximum number of starts per hour. If the pump executes a number of starts per hour higher than the set value it will be stopped and an alarm will activate. The functional operation of the pump will be inhibited until the reset of the alarm. The reset of the alarm will happen automatically at the end of the hour. The "X" indicates the setting of the parameter to modify. The range of value is from 1 to 99. Factory default setting: 6.

To continue programming the parameters of the pump press the button  to go back to the parameter "Enable Max Start Hour":

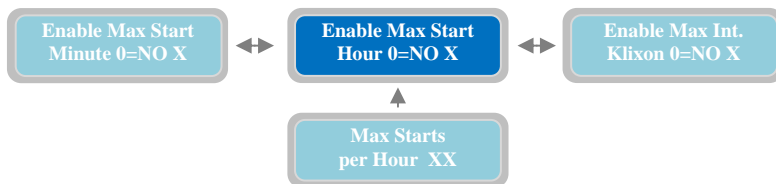

To move to the next horizontal parameter press the button  :

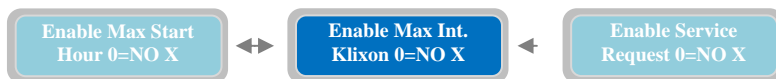

Enable Max Int. Klixon 0=NO X

The parameter "Enable Max Interventions Klixon" will enable/disable the alarm for the maximum number of Klixon events for the pump. When enabled and the number of Klixon events on the pump is higher than the set value in the parameter "Max Intervention Klixon" the alarm will be activated and the pump will stop. The functional operation of the pump will be inhibited until the reset of the alarm. The Klixon is a thermal protection circuit breaker (available only on some types of pumps) inserted in the motor to prevent overheating (typically due to an excessive number of starts within a short period of time or due to a defective cooling system of the motor). Typically it is a bimetallic circuit breaker that provides a contact normally closed that would open in case of overheating. The re-closing of the contact (and reactivation of Klixon) is automatic once the temperature has dropped, below the value determined not to be harmful to the system. The "X" indicates the setting of the parameter to modify.
0=NO: setting "0" will disable the alarm for the maximum number of Klixon events
1=YES: setting "1" will enable the alarm for the maximum number of Klixon events
Factory default setting: 1 (enable).

Press the button  to move to the menu for setting the maximum number of interventions Klixon ("Max Intervention Klixon P1"):

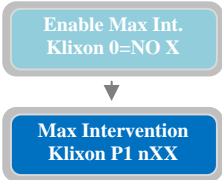

The parameter "Max interventions Klixon P1" will set the max number of Klixon events that the pump can handle. If the number of Klixon events is higher than the set value the pump will be stopped and therefore the alarm will activate (XTREME will sum the Klixon events independently from the frequency of starts over time; the alarm will happen even if the number of events is reached over a long period of time). The functional operation of the pump will be inhibited until the reset of the alarm.
 The "X" indicates the setting of the parameter to modify.
 The range of value is from 1 to 10.
 Factory default setting: 1.

To continue programming the parameters of the pump press the button  to go back to the parameter "Enable Max Int. Klixon":

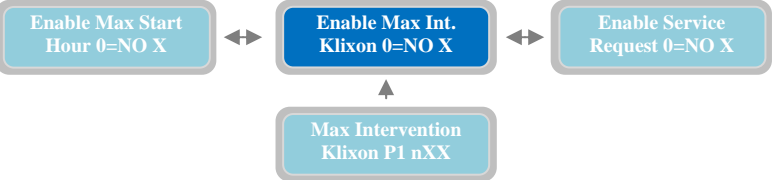

To move to the next horizontal parameter press the button  :



The parameter "Enable Service Request" will enable/disable the alarm for the service maintenance of the pump. When it is enabled the pump will work and the pump works for a number of hours higher than the set value in the parameter "P1 Request Service" there will be an alarm for maintenance/substitution of the pump. The pump will not be stopped and it will continue to work normally. The alarm will be displayed and it will be possible to activate one or more alarm outputs (based on the setting in the menu "Alarms Setting").
 The "X" indicates the setting of the parameter to modify.
 0=NO: setting "0" will disable the alarm for service request.
 1=YES: setting "1" will enable the alarm for service request.
 Factory default setting: 0 (disable).

Press the button  to move to the menu for setting the maximum number of working hours ("P1 Request Service"):

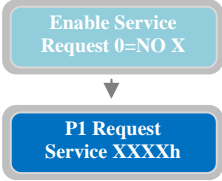



The parameter "P1 Request Service" will set the maximum number of working hours for the pump before the service request alarm is activated. The alarm will be displayed and it will be possible to activate one or more alarm output (based on the setting in the menu "Alarms Setting").
 The "X" indicates the setting of the parameter to modify.
 The range of value is from 1 to 9999 hours.
 Factory default setting: 1000h.

Press the button  to move to the next horizontal parameter "Reset Service P1":



The parameter "Reset Service P1" will show the number of hours until the for maintenance service request alarm will be activated.

Press the button  to update the time remaining for the next service with the pump's duration of work already executed (the value will be displayed on the parameters "h XXX"). At this point the next service request will happen after "time set on the parameter P1 service request" + "work time on the operating parameter". If there is no "Reset Service P1" and the time it is simply set via "P1 Request Service", the maintenance service request alarm will activate considering the number of work hours already executed. For example, if the pump has already worked for 200h and the "P1 Request Service" was set to 1000h and there was no reset of P1. Then, the service request alarm will activate once the 1000h of work are reached, meaning in 800h (1000-200=800h). If the reset of service P1 is done, the service request alarm will at 1200h of work hours (200+1000=1200h). To figure out the time remaining for the service request it is necessary to verify the number of hours indicated on the parameter "Reset Service P1" and subtract the number of hours displayed on the operating parameter "h XXX".

Press the button  to go back to the horizontal parameter "Enable Service Request":

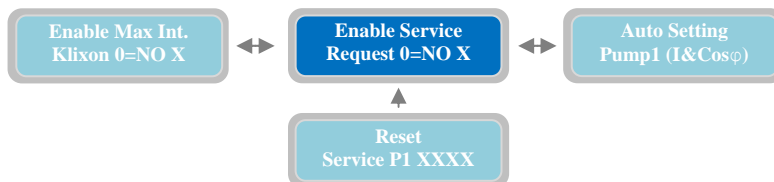

To move to the next horizontal parameter press the button  :

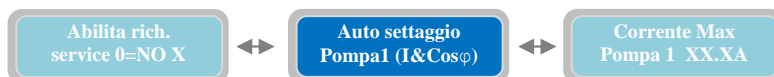

The parameter "Auto Setting pump 1" is to set the control panel automatically for the main electrical parameters of the pump. When pressing the button  the pump will start and will work for 10 seconds; in this period of time the control panel XTREME will read the electrical parameters of the pump (current, Cosφ). After the 10 seconds the values read will be automatically saved.

WARNING: the auto setting of the pump is executed independently from the conditions of the system (pump flow closed, consents of operation whether active or not, etc ...).

To avoid damage to the pump and the electrical parameters erroneous readings, before making the auto setting make sure that the working conditions of the pump are the best ones.

Note: based on the measurements of current and cosφ during the auto setting XTREME will set the following parameters automatically:

- "I Min" is set as 60% of the current measured during the auto setting.
- "I max" is set as 120% of the current measured during the auto setting.
- "Cosφ Min" is set as 80% of the cosφ measured during the auto setting.

If the Auto Setting of the parameters of the pump is not desired, it is possible to set manually the values with the following parameters.

To move to the next horizontal parameter press the button  :



The parameter "Max Current Pump 1" will set the maximum value of current consumption allowed (overcurrent). Beyond the set value (for the duration specified in the parameter "P1 Delay Alarm I_{max}") the pump will stop and will display an alarm (Maximum current) and it will be possible to activate one or more alarm output (based on the setting in the menu "Alarms Setting").

The "X" indicates the setting of the parameter to modify.

The range of value is from 00.1 to 99.9 A.

Factory default setting: 00.0 A.

To move to the next horizontal parameter press the button  :



In the parameter "Min pump current 1" it is possible to set the minimum value that the current absorbed by the pump (undercurrent) can assume. If the absorbed current value is lower than the set value (for the time delay set in parameter "P1 Imin alarm delay") the pump will stop, the "Run dry" alarm will appear on the display and one or more can be activated. alarm outputs (depending on the settings made on the "Alarm settings" menu). Always check the value taken after each autoset.
(the "X" indicates the position of the modifiable parameter).
Setting "0.00" the pump alarm is deactivated.
It is possible to set a value between 00.1 and 99.9 A.
Default setting: 00.0 A.

To move to the next horizontal parameter press the button  :



In the parameter "Cosφ Minimum pump 1" it is possible to set the minimum value that can be assumed by the cosφ in pump operation (the lowering of the Cosφ value indicates that the pump is not sucking water and is working dry): if the value of cosφ is less than the set value (for the time delay set on parameter "P1 Cosφ alarm delay") the pump will stop, the "Start dry" alarm will appear on the display and one or more alarm outputs can be activated (in function of the settings made on the "Alarm settings" menu). Always check the value taken after each autoset.
(the "X" indicates the position of the modifiable parameter).
Setting "0.00" the pump alarm is deactivated.
It is possible to set a value between 0.20 and 0.99.
Default setting: 0.20.

At this point the horizontal menu "Settings Pump" has been fully programmed and you can proceed to the next menu.

To go back to the horizontal menu "Settings Pump" press the button .



Press again the button  to move to the next horizontal menu "Operating Programs":

12. OPERATING PROGRAMS



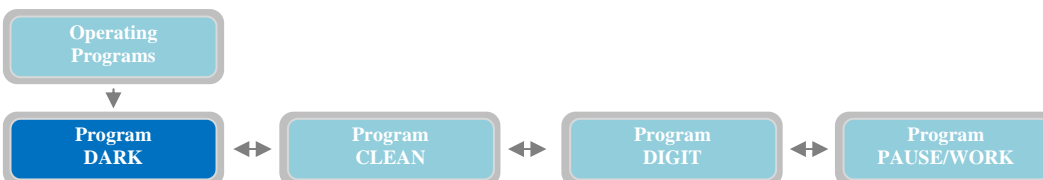

Press the button  to display the vertical parameter:



In this part of the of control panel setting it's possible to choose the program operating mode for the pumps. Four program operating modes are available:

- Program DARK
- Program CLEAN
- Program DIGIT
- Program PAUSE/WORK

The first operating mode is the program DARK (to select a different program mode just press the buttons  and  to move in the horizontal menu of programs).

Program
DARK

Inside the menu "Program DARK" is possible to activate/deactivate the operating mode "Dark" for the pumps (this operating mode will apply to all the pumps connected). The program Dark is particularly suitable for systems managing waste water (this program mode can also be used for clean water system). Especially suitable for a system using float switches, the program Dark can be used also with generic dry contacts. The main characteristic of operation of the program Dark is that the pumps start is controlled via a start float switch and its operation will continue even after the "start switch" deactivation. The stopping of the pump is controlled by the activation of its stop float switch.

Program
CLEAN

Inside the menu "Program CLEAN" is possible to activate/deactivate the operating mode "Clean" for the pumps (this operating mode will apply to all the pumps connected). The program Clean is particularly suitable for systems managing clean water (this program mode can also be used for waste water system). Especially suitable for system using either pressure switches or float switches, the program Clean can be used also with generic dry contacts. With the program Clean the starting and stopping of the pumps are controlled via the start float switch; it is possible to connect to a minimum level float switch as additional protection against dry running operation.

Program
DIGIT

Inside the menu "Program DIGIT" is possible to activate/deactivate the operating mode "DIGIT" for the pumps (this operating mode will apply to all the pumps connected). The program DIGIT allows the starting and stopping of the pumps based on a signal coming from 4-20 mA device (for example, level piezoresistive sensor, electronic pressure transducer,...). It is possible to control the starting and stopping of the pumps based on some levels/pressures programmable by the operator.

Program
PAUSE/WORK

Inside the menu "Program PAUSE/WORK" is possible to activate/deactivate the operating mode "PAUSE/WORK". The program PAUSE/WORK allows managing the operation of the pumps only with two timing, independent of the inputs, defined for each pump, the pause (downtime pump) and work (pump start-up time), modified in the following pages with units measuring in minutes. The program PAUSE / WORK is particularly suitable in systems with pumps inserted in different tanks and / or which work with predetermined intervals.

NOTE: regardless of the program operating mode selected, it is always possible to connect to a 4-20mA device to display the level/pressure and to alarm for minimum/maximum level/pressure. In addition, with the program operating mode DIGIT it is also possible to set the actual levels/pressure values to control the pumps

To proceed and set all the parameters of the operating mode DARK press the button :

Program
DARK

Operating mode
Empty/Fill X

The parameter "Operating mode Empty/Fill" will set the mode of the program "Dark" to "empty" or "fill". With "Empty" the start/stop float switches of the pumps are inside the tank in which the pump is installed. With "Fill" the start/stop float switches are in a different tank from which the pumps are installed.

The "X" indicates the setting of the parameter to modify.

0=EMPTY

1=FILL

Factory default setting: 0 (Empty).

To move to the next horizontal parameter press the button  :



The parameter "Enable DARK" will enable/disable the program operating mode Dark. Once enabled the mode Dark it will apply to all the installed pumps.

To enable the operating mode Dark press the button  to save its setting. The display will show briefly the message "save" as confirmation that the setting has been saved. In the main display the word "drk" will show to indicate the selected program operating mode.

The setting of all the parameters for the program operating mode Dark is complete.

Refer to section "INSTALLATION EXAMPLES" for directions of the connections and the applications of the mode DARK.

Similarly to the previous program operating mode, it is possible to select "Program CLEAN" and set all its parameters.

To proceed and set all the parameters of the operating mode Clean press the button  :



The parameter "Operating mode Empty/Fill" will set the mode of the program "Clean" to "empty" or "fill". Typically with "Empty" the start/stop float or pressure switches of the pumps are inside the tank in which the pump is installed. With "Fill" the start/stop float or pressure switches are in a different tank from which the pumps are installed.

The "X" indicates the setting of the parameter to modify.

0=EMPTY

1=FILL

Factory default setting: 0 (Empty).

To move to the next horizontal parameter press the button  :



The parameter "Enable CLEAN" will enable/disable the program operating mode Clean. Once enabled the mode CLEAN it will apply to all the installed pumps.

To enable the operating mode Clean press the button  to save its setting. The display will show briefly the message "save" as confirmation that the setting has been saved. In the main display the word "cln" will show to indicate the selected program operating mode.

Factory default setting: CLEAN enable.

The setting of all the parameters for the program CLEAN operating mode is complete.

Refer to section "INSTALLATION EXAMPLES" for directions of the connections and the applications of the mode CLEAN.

Similarly of the previous program operating mode, it is possible to select "Program DIGIT" and set all its parameters.

To proceed and set all the parameters of the operating mode DIGIT press the button  :

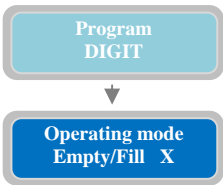

The parameter "Operating mode Empty/Fill" will set the mode of the program "Digit" to "empty" or "fill". Typically with "Empty" the 4-20 mA devices are inside the tank in which the pump is installed. Typically, with "Fill" the 4-20 mA devices are in a different tank from which the pumps are installed.
 The "X" indicates the setting of the parameter to modify.
 0=EMPTY
 1=FILL
 Factory default setting: 0 (Empty).

To move to the next horizontal parameter press the button  :



The parameter "Enable DIGIT" will enable/disable the program operating mode DIGIT. Once enable the mode DIGIT it will apply to all the installed pumps.
 To enable the operating mode DIGIT press the button  to save its setting. The display will show briefly the message "save" as confirmation that the setting has been saved. In the main display the word "Dig" will show to indicate the selected program operating mode.

NOTE: the setting of the alarm level/pressure and commands of the pumps of operating mode DIGIT are under the submenu "Enable 4-20 mA" of the menu "General Settings". The setting of the level/pressure needs to be consistent with the logical of operating mode selection (empty or fill).

The setting of all the parameters for the program operating mode DIGIT is complete.

Refer to section "INSTALLATION EXAMPLES" for directions of the connections and the applications of the mode DIGIT.

Similarly of the previous program operating mode, it is possible to select "Program PAUSE/WORK" and set all its parameters.

To proceed and set all the parameters of the operating mode PAUSE/WORK press the button  :

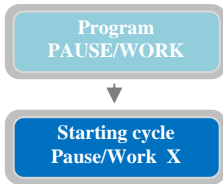

With the parameter "Starting cycle Pause/Work" is possible to select if the operating program "PAUSE/WORK" must start the operating cycle from the pause time or work time.
 The "X" indicates the setting of the parameter to modify.
 0=PAUSE
 1=WORK
 Factory default setting: 0.

To move to the next horizontal parameter press the button  :



With the parameter "Pause Time P1" is possible to set the duration of the pause time in the operation of the pump P1.
 The "X" indicates the setting of the parameter to modify.
 The range of value is from 1 to 999 minutes.
 Factory default setting: 200.

To move to the next horizontal parameter press the button  :



Work Time
P1 XXXmin



With the parameter "Work Time P1" is possible to set the duration of working time in the operation of the pump P1.
The "X" indicates the setting of the parameter to modify.
The range of value is from 1 to 999 minutes.
Factory default setting: 100.

To move to the next horizontal parameter press the button  :



Enable
PAUSE/WORK

With the parameter "Enable PAUSE/WORK" is possible to activate/deactivate the operating program PAUSE/WORK. Once activated, the program operation PAUSE/WORK will be active for all the pumps installed.
To activate the operating program PAUSE/WORK or simply restart the cycle just press the button  to save the setting. The display will briefly display "save" to indicate has been saved. In the basic screen of the display will show "p/w" to indicate the operating program selected.

NOTE: a) By pressing the button  the corresponding timer starts, by pressing  stops
b) Holding down the button  for 2 sec recharges the corresponding timer of the current state
c) If you change the operating logic or press the enter button on the page 'Enable PAUSE/WORK' reloads all timers and the status of starting
d) If you change only pause or work times of a pump are reloaded timers restarting the pump from the current state
e) Each time the panel is turned on, is recharged the time of the status interrupted.

At this point the horizontal menu "Operation Programs" has been fully programmed and you can proceed to the next menu.

To go back to the horizontal menu "Operation Programs" press the button .

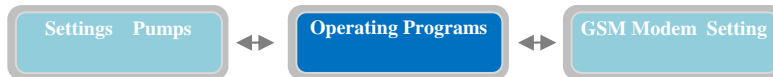

Press the button  to move to the next horizontal menu "GSM Modem Setting"

13. GSM MODEM SETTING



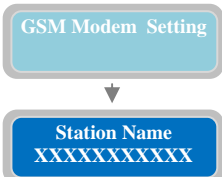

Press the button  to visualize the underneath vertical parameter:



With the vertical parameter "Station Name" is possible to give a name the control panel/system. The name will show in the SMS reply every time there will be a GSM connection test (see following parameters).
Factory default setting: "Test gsm ok".

NOTE: Before configuring the GSM modem wait almost 1 minute after turning on the panel in order to successfully complete its startup routine. To proceed must be present inside the SIM.

By pressing buttons  and  is possible to select uppercase, lowercase and numbers.

To move to the next horizontal parameter press the button  :



**Enable Modem
YES/NO X**

The parameter "Enable Mode" will enable/disable the modem GSM functionality. The "X" indicates the setting of the parameter to modify.
 0=MODEM DISABLE
 1=MODEM ENABLE
 Factory default setting: 0 (Enable).
 Once the modem is enabled the main display will show "gsm" on the top right corner to indicate the modem is present and enabled. In case the modem is enabled but it's not physically present inside the control panel then the display "gsm" will not appear in the main display.

To move to the next horizontal parameter press the button  :



**Phone nr.1
+XXXXXXXXXX**

The parameter "Phone nr.1" will set the first (3 in total) phone number to send the SMS messages for the status and alarms as well as the phone number allowed to remotely control the various parameter settings. The number needs to be entered with international prefix (for example, +44.....) without any spaces.
 Note: there is no priority among the 3 phone numbers; they are independent from each other.
 Factory default setting: +0000000000.

To move to the next horizontal parameter press the button  :



**Phone nr.2
+XXXXXXXXXX**

The parameter "Phone nr.2" will set the second (3 in total) phone number to send the SMS messages for the status and alarms as well as the phone number allowed to remotely control the various parameter settings. The number needs to be entered with international prefix (for example, +44.....) without any spaces.
 Factory default setting: +0000000000.

To move to the next horizontal parameter press the button  :



**Phone nr.3
+XXXXXXXXXX**

The parameter "Phone nr.3" will set the third and last phone number which to send the SMS messages for the status and alarms as well as the phone number allowed to remotely control the various parameter settings. The number needs to be entered with international prefix (for example, +44.....) without any spaces.
 Factory default setting: +0000000000.

To move to the next horizontal parameter press the button  :

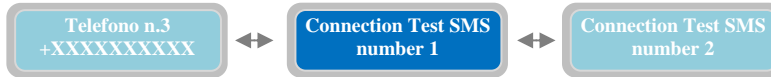

NOTE: In order for the GSM module to work correctly, never leave the line for entering the users' telephone numbers completely empty, in the event someone is not necessary, leave at least the international prefix (eg +39). If an invalid number is entered, the SMS sending procedure will also be aborted for subsequent numbers. Correct or disable the number and then switch the ignition off and on again.

Connection Test SMS number 1

The parameter "Connection Test SMS number 1" will verify that the communication between the modem GSM and the "Phone nr.1" is working. To verify it, press the button which will send an SMS message immediately from the modem GSM. The text of the message is described in setting "Station Name".

NOTE: when the setting to enable/disable the modem GSM is changed (change of parameter "Enable Modem") it is necessary to exit the programming and re-enter prior to test the connections.

To move to the next horizontal parameter press the button :



Connection Test SMS number 2

Similarly to the previous parameter, "Connection Test SMS number 2" will verify that the communication between the modem GSM and the "Phone nr.2" is working. To verify it, press the button which will send an SMS message immediately from the modem GSM. The text of the message is described in setting "Station Name".

To move to the next horizontal parameter press the button :



Connection Test SMS number 3

The parameter "Connection Test SMS number 3" will verify that the communication between the modem GSM and the "Phone nr.3" is working. To verify it, press the button which will send an SMS message immediately from the modem GSM. The text of the message is described in setting "Station Name".

NOTE: the GSM card has an LED to verify the network operator presence (see chapter "GSM" on page 40).

At this point the horizontal menu "GSM Modem Setting" has been fully programmed and it's possible to proceed to the next menu.

To go back to the horizontal menu press the button , we are back to horizontal menu "GSM Modem Setting":



Press again the button to move to next horizontal menu "Alarms Setting"

14. ALARM SETTING



Press the button to display the vertical parameter:

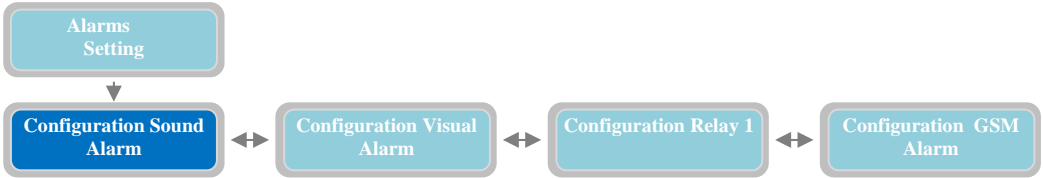

In this part of the programming it is possible to select the operating mode for the alarm outputs available:

- Sound Alarm
- Visual Alarm
- Relay 1
- GSM Alarm

The first alarm output on the list is the Sound Alarm (to move to a different alarm output just press the buttons and to navigate on the horizontal menu).



The vertical parameter "Configuration Sound Alarm" will set the operating mode of the audio alarm output on the control panel. It is an output voltage 12 Vcc, max 30 mA) with faston connector (see page 40). This is set-up to be connected to a buzzer alarm but it could be used for any other device with the following electrical characteristics: 12 Vcc, 30 mA max.

Press the button to configure the Sound Alarm:

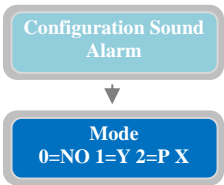

The parameter "Mode" will select the operating mode of the sound alarm output. The "X" indicates the setting of the parameter to modify.
 0=NO (Off)
 1=YES in the presence of an alarm (among the selected in the next parameter) the alarm output is on and the connected device will activate.
 In the absence of an alarm the output is off and the connected device is turned off.
 2=PULSED: in the presence of an alarm (among the selected in the next parameter) the alarm output is on with intermittent pulses and the connected device will activate intermittently.
 In the absence of an alarm the output is off and the connected device is turned off
 Factory default setting: 1

To move to the next horizontal parameter press the button :



The parameter "Configuration" sound alarm output is possible to set which alarms will activate the output (with mode described in the previous parameter). The "X" indicates the setting of the parameter to modify.
 Factory default setting: 100111111100110.

It is possible to activate the sound alarm output (and also all the other alarm outputs described later) for 15 types of alarms. One or more alarms can be activated as desired. To activate an alarm set the value from "0" to "1" in the following table

		ALARM ON	1	1	1	1	1	1	1	1	1	1	1	1	1	1	1	1
		ALARM OFF	0	0	0	0	0	0	0	0	0	0	0	0	0	0	0	0
1	V Min, V Max																	1
2	Phase Seq., Min Hz, Max Hz																	1
3	4-20 mA device malfunction																	1
4	Min level																	not be disabled
5	Max level																	not be disabled
6	Pump 1 alarms																	not be disabled
7	Pump 2 alarms																	not be disabled
8	Pump 3 alarms																	not be disabled
9	I Min, cosφ Min																	not be disabled
10	I max																	not be disabled
11	Service																	not be disabled
12	Max start per minute, Max start per hour																	not be disabled
13	Max Klixon interventions																	not be disabled
14	Detection of water in oil chamber																	not be disabled
15	Max continuous working																	not be disabled
16	<i>(only whit GSM modem)</i> Absence/Return mains																	not be disabled
17	<i>(only whit GSM modem)</i> Black-out Max level																	not be disabled
18	<i>(only whit GSM modem)</i> Low battery																	not be disabled

NOTE: the alarms in gray are automatically sent only if is mounted GSM modem. There is no need any configuration and it's not possible to disable these features.

For example, the mask "100110000000000" will activate the following alarms: V Min, V Max, Min Level e Max Level.

The XTREME¹ always shows to display each alarm detected, but it will activate the alarm output only if it's configured properly.

N.B.: The alarms "I Min, cos φ Min", "I max", "Service Request", "Max Starts per Minute/Hour", "Intervention Klixon", "Water in Oil Chamber" e "Max Continuous Operation", TO BE ACTIVATED, MUST BE ASSOCIATED TO AT LEAST ONE PUMP; THERE MUST BE ACTIVE AT LEAST ONE OF THE "ALARMS PUMP".

To go back to the horizontal menu press the button . Back to the horizontal menu "Configuration Sound Alarm":



Press the button  to move to the configuration of the next alarm output :



Configuration Visual Alarm

The vertical parameter "Configuration Sound Alarm" will set the operating mode of the visual alarm output on GSM card (therefore, GSM option must be present). It is an output voltage 12 Vcc, max 30 mA) with faston connector (see page 41). This is set-up to be connected to a flashing alarm but it could be used for any other device with the following electrical characteristics: 12 Vcc, 30 mA max. Factory default setting: 100111111100110.

NOTE: for the setting of the Visual alarm output please refer the description of the Sound alarm output.

To go back to the horizontal menu press the button . Back to the horizontal menu "Configuration Visual Alarm":



Press the button  to move to the configuration of the next alarm output :



Configuration Relay 1

The vertical parameter "Configuration Relay 1" will set the operating mode of the Q1 alarm output on the control panel. It is an output relay with changeover contact (voltage free) with screw terminals connectors (see page 40) (electric contacts characteristics: 250Vac, 5A in AC1). The following contacts will be present in the terminals:
 -COM: common
 -N.C.: contact normally closed
 -N.A.: contact normally open
 The output can be used to send the status of alarm to a device with dry contacts or to drive via relay contacts a device to be activated with a separate power supply.

NOTE: to set the relay 1 alarm output please refer to the sound alarm output configuration setting section.

To go back to the horizontal menu press the button . Back to the horizontal menu "Configuration Relay 1":



Press the button  to move to the configuration of the next alarm output :



Configuration GSM Alarm

The vertical parameter "Configuration GSM Alarm" it is possible to define which alarms will be send to the phone numbers specified in the menu "Setting GSM Modem".

Press the button  to configure the GSM Alarm:

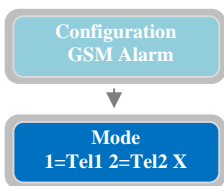

The parameter "Mode" of the GSM Alarm will set the mode to send the SMS messages of alarm. Every GSM Modem installed in the XTREME can manage up to a maximum of 3 phone numbers; This "Mode" parameter will set which phone numbers to send the SMS Alarms. The "X" indicates the setting of the parameter to modify.
 0=NOT IN USE (no SMS alarm will be sent)
 1=Send SMS only to "Phone nr.1"
 2=Send SMS only to "Phone nr.2"
 3=Send SMS to "Phone nr.1" and "Phone nr.2"
 4=Send SMS only to "Phone nr.3"
 5=Send SMS to "Phone nr.1" and "Phone nr.3"
 6=Send SMS to "Phone nr.2" and "Phone nr.3"
 7=Send SMS to "Phone nr.1", "Phone nr.2", and "Phone nr.3".
 Factory default setting: 0.

To move to the next horizontal parameter press the button  :



With the parameter "Configuration" GSM Model alarm output is possible to set which alarms will trigger the sending of the SMS messages (with the Mode previously described) The "X" indicates the setting of the parameter to modify. Factory default setting: 0000000000000000.

NOTE: to set the GSM alarm output please refer to the sound alarm output configuration setting section

To go back to the horizontal menus press the button  and the "Alarms Setting" menu will be displayed again



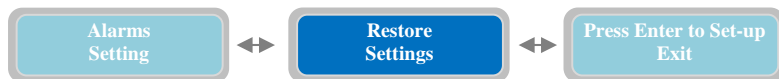

Press again the button  to move to next horizontal menu "Restore Settings"

15. RESTORE SETTINGS

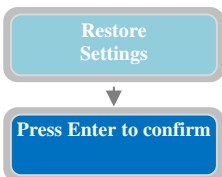

Press the button  to display the vertical parameter:



On the "Enter to confirm" can be performed restore all the programming parameters to the default status that is the initial factory settings.
To confirm, simply press the button  to which will correspond an instant restart of the software.
This option is particularly useful if it is desired to change the parameters of the system without having to control all of.

16. ALARM LIST

ALARM		CAUSE	REMEDY
Max Continuous Working Pump X	R	The pump indicated has reached the continuous operation time set by parameter: 'Max Continuous Working' (p. 24)	Check the system or the function of the inputs
Max Starts per Minute Pump X	R	The pump indicated has reached the number of starts in a minute set with parameter: 'Max Starts per Minute' (p. 24)	Check the system or the function of the inputs
Max Starts per Hour Pump X	R	The pump indicated has reached the number of starts per hour set with parameter: 'Max Starts per Hour' (p. 24)	Check the system or the function of the inputs
Water in the Oil Chamber Pump X	R	The contact of the sensor inside the pump indicated detects the presence of water in the oil chamber	Check pump
Operation Klixon Pump X	R	The klixon contact of the pump indicated is open	Check pump or jumper the input if not used
Dry Running Pump X	R	The pump indicated has absorbed the minimum current value set by parameter: 'Min Current PX (p. 28) for the time set with the parameter: 'PX Alarm Delay Imin '(p. 23) or reached the minimum value of $\cos\phi$ set by parameter: 'Cos ϕ Min PX' (p. 28) for the time set with the parameter: 'PX Alarm Delay $\cos\phi$ ' (p. 23)	Check the fluid level in the pump suction or repeat the autosest parameters
Overcurrent Pump X	R	The pump indicated has absorbed the maximum current set with the parameter: 'Max Current PX (p. 27) for the time set with the parameter: 'PX Alarm Delay Imax' (p. 23)	Check the pump and repeat the self parameter setting
Power Failure Alarm	A	Alarm on APP sent only with GSM module present and active	Check connections or cable connections of power to the panel
Abnormal Frequency (Hz)	A	The supply frequency has exceeded the limits set by the parameter: 'Max Difference Freq.' (P. 17) for the time set with the parameter: 'Delay Alarm Freq.' (P. 17)	Verify and monitor the power frequency to the panel
Wrong Phase Sequence Alarm	R	Incorrect phase sequence of the supply voltage (This alarm only XTREME-T)	Check the connections or cables or reverse two phases of power to the panel
Phase Loss Alarm	R	Absence of a phase of the supply voltage (This alarm only XTREME-T)	Check connections or cable connections of power to the panel
Maximum Voltage Vmax Alarm	R	The supply voltage has exceeded the maximum value set by parameter: 'Setting Alarm Vmax' (p. 16) for the time set with the parameter: 'Delay Alarm Voltage' (p. 16)	Verify and monitor the supply voltage of the panel
Minimum Voltage Vmin Alarm	R	The supply voltage was above the minimum set by parameter: 'Setting Alarm Vmin' (p. 16) for the time set with the parameter: 'Delay Alarm Voltage' (p. 16)	Verify and monitor the supply voltage of the panel
Max Lev-Press Alarm	A	The alarm input at the highest level/pressure is closed	Check the installation or operation of alarm devices
Min Lev-Press Alarm	A	The alarm input of a minimum level/pressure is opened	Check the installation or operation of alarm devices
4÷20mA Sensor Disconnected	R	The sensor input is not connected	Check sensor or the polarity of the cable connection
Anomaly to the 4÷20mA Sensor	R	The measurement sensor never varies	Check sensor or the polarity of the cable connection
Pump X Disconnected	R	The pump indicated does not absorb current though there is a request to start	Check connections or cable connections power the pumps
Service Request Pump X	R	The pump indicated has exceeded the number of working hours required for the maintenance set with the parameter: 'PX Request Service' (p. 26)	Service the pump

X = variable that the system replaces with the number of the pump.

R = RETENTIVE (requires a manual reset even if the cause of the alarm disappears)

A = AUTORESET (reset the alarm if it disappears the cause)

17. ELECTRIC CONNECTIONS



Connection of the control signals and protection on the main board

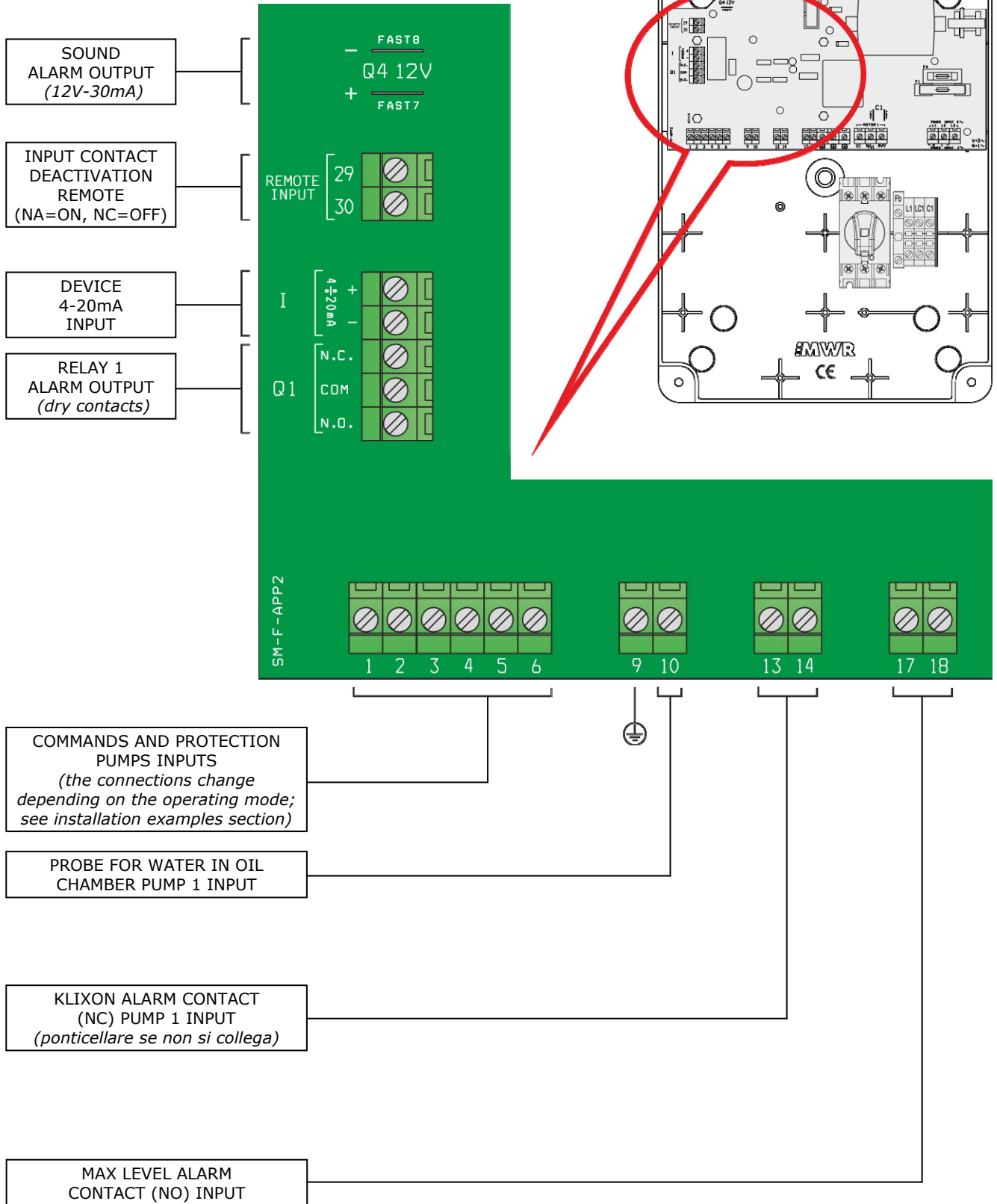

NOTE: For proper operation of the water in the oil chamber detections probes (if installed), make sure that the earth (PE) of the pumps is equipotential to the earth (PE) of the control panel.

Connection of the alarm and protection signals on the GSM board
 Quad-Band GSM 850/900 / 1800/1900 MHz - which operates in 2G
(optional board)

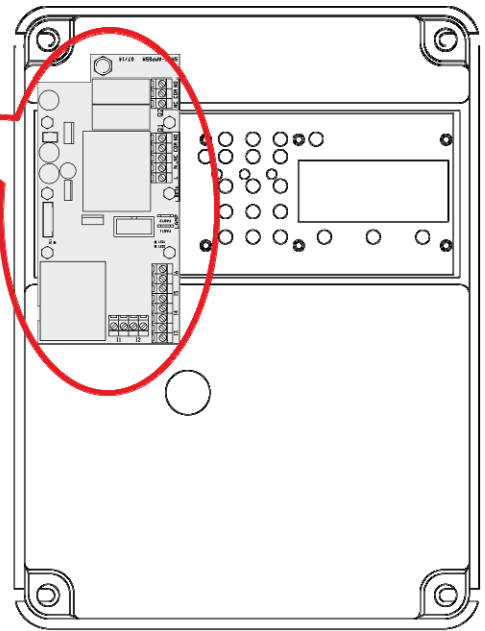
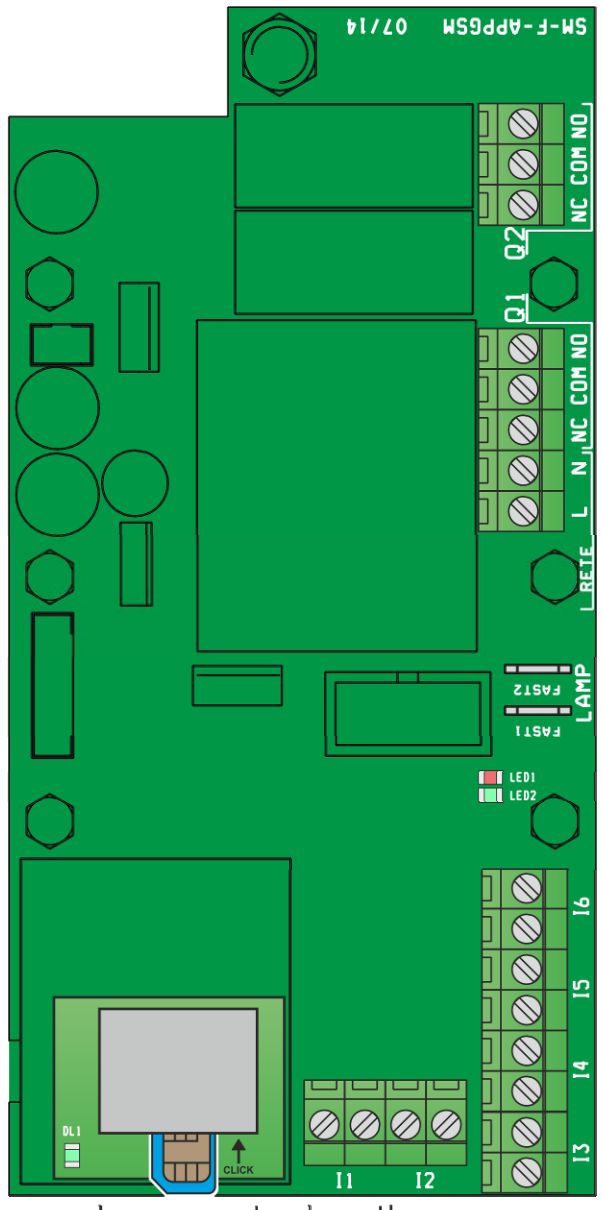

- NOT USED INPUT
- SUPPLY BOARD (230-400Vac)
- VISUAL ALARM OUTPUT (12V-30mA)

- LED 1 red:**
- FIXED ON: gsm not configured
 - FLASHING: alarm active
 - OFF: OK!
(GSM configured and no active alarm)
- LED 2 green:**
- FIXED ON: OK!
(software gsm properly functioning)
 - OFF: software malfunction
- LED 1 (fixed on) + LED 2 (flashing):**
 update parameters in progress

NOT USED INPUT

Before inserting the SIM card, proceed as follows:

- **DISABLE THE PIN CODE** using a mobile phone,
- **DISABLE THE ANSWERING MACHINE.**

To insert the SIM card in the device is required:

- turn off the control panel and open the cover with caution
- unlock the door of the GSM module pushing it up and lift it up
- insert the SIM card in the door with its chip facing the contacts and its diagonal corner in the lower-right position;
- lower the door and push it gently downwards
- close the cover and turn on the control panel.

The sim card is always to be inserted and/or removed with the system TURNED OFF.

The device works with either prepaid or subscription SIM cards as well as data SIM cards **that operate on 2G.**

MAXIMUM LEVEL ALARM CONTACT (NO) INPUT IN BLACK-OUT:
 it is a further input (in addition to that on the main board), usually connected to a float for signaling, by means of sending of SMS, the alarm of the highest level active only in case of black-out.
 When the power supply is on the input turns off. It is not necessary any setting, it is activated automatically when you enable the GSM card.

DL 1 green:

- FIXED ON (4-5 sec.): power-up routine in progress
- FLASHING FAST (1 sec.): GSM network search
- FLASHING SLOW (3 sec.): GSM network attached



Connection of the power supply and single-phase pump with internal capacitor (embedded)

1~

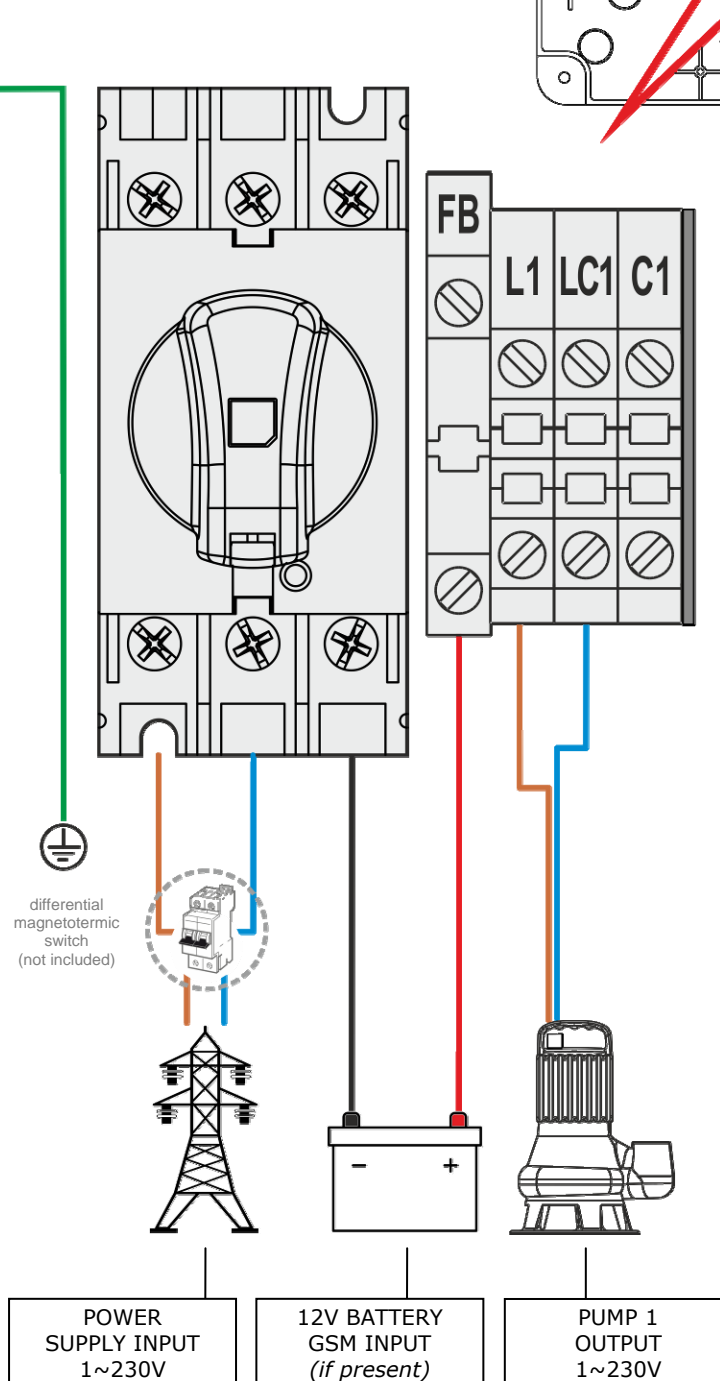
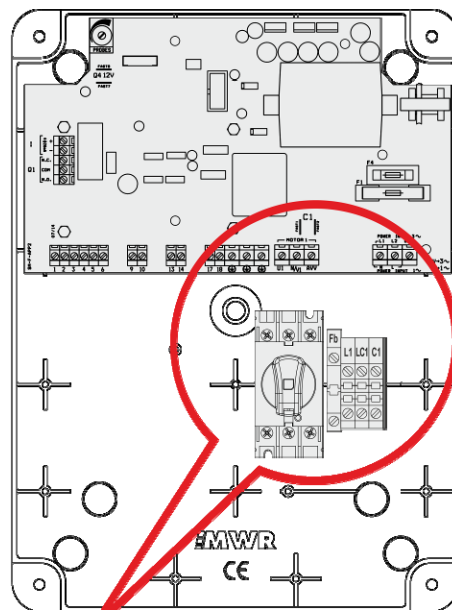
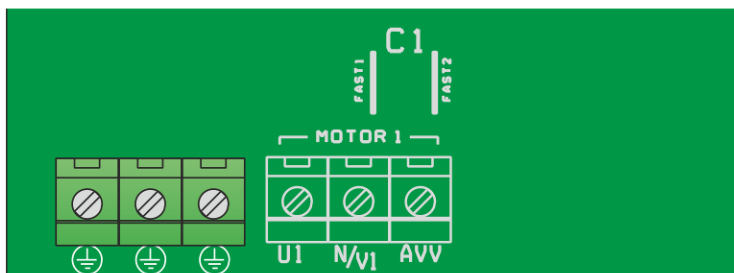

Connection of the power supply and single-phase pump with external capacitor

C1: STARTING CAP. PUMP 1

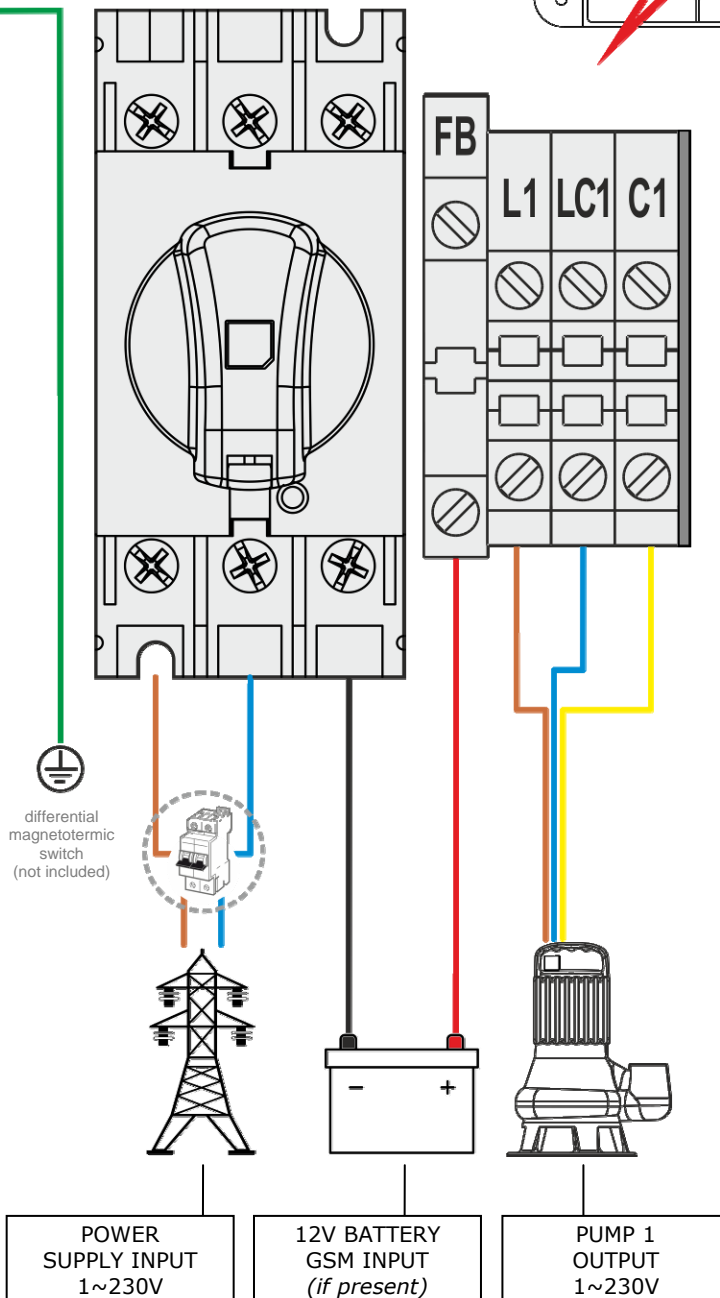
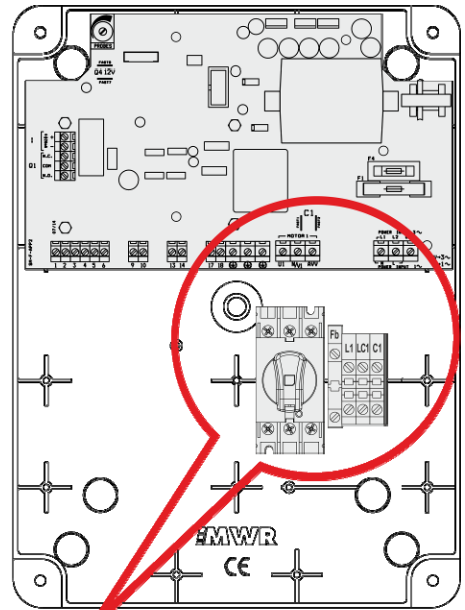
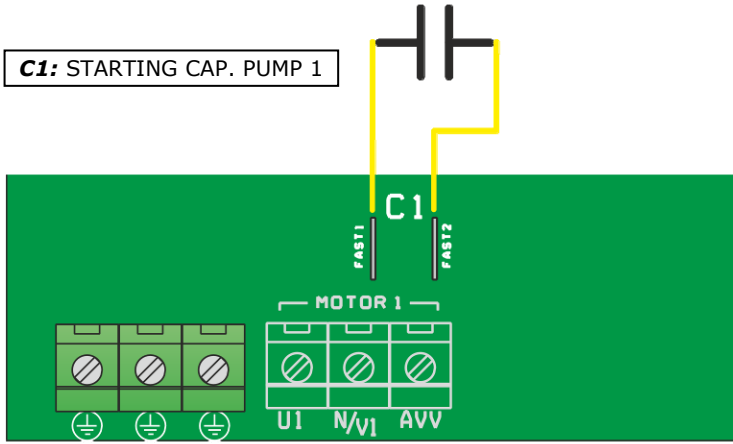

Connection of the power supply and three-phase pump

3~

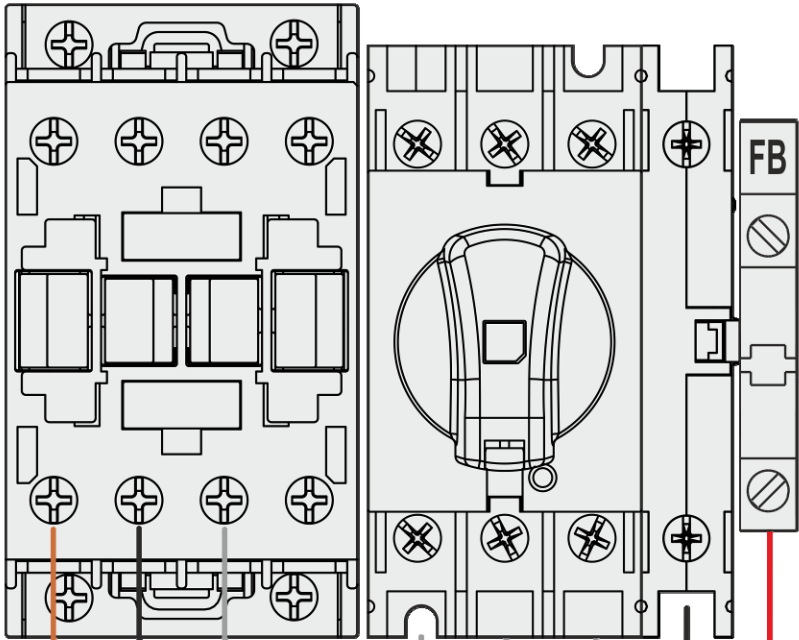
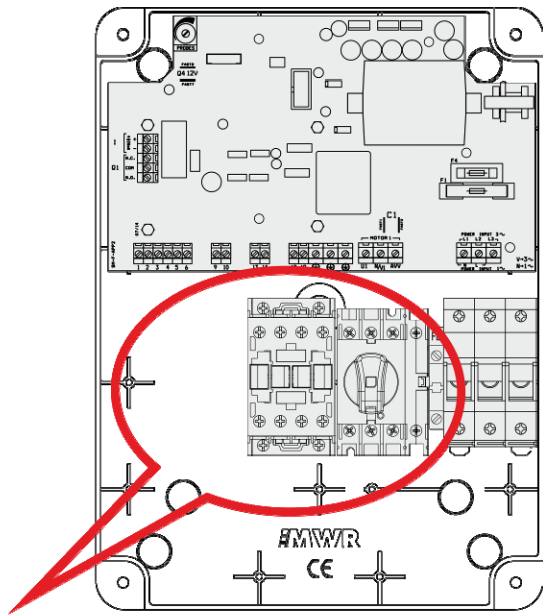
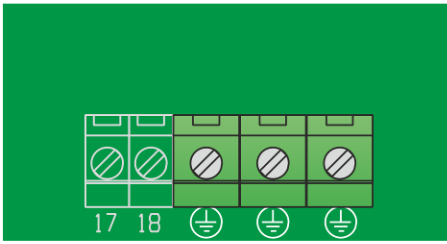

differential magnetotermic switch (not included)

PUMP 1
OUTPUT
3~400V
3~230V

POWER
SUPPLY INPUT
3~400V
3~230V

12V BATTERY
GSM INPUT
(if present)

18. APPLICATION EXAMPLES



DARK [empty]

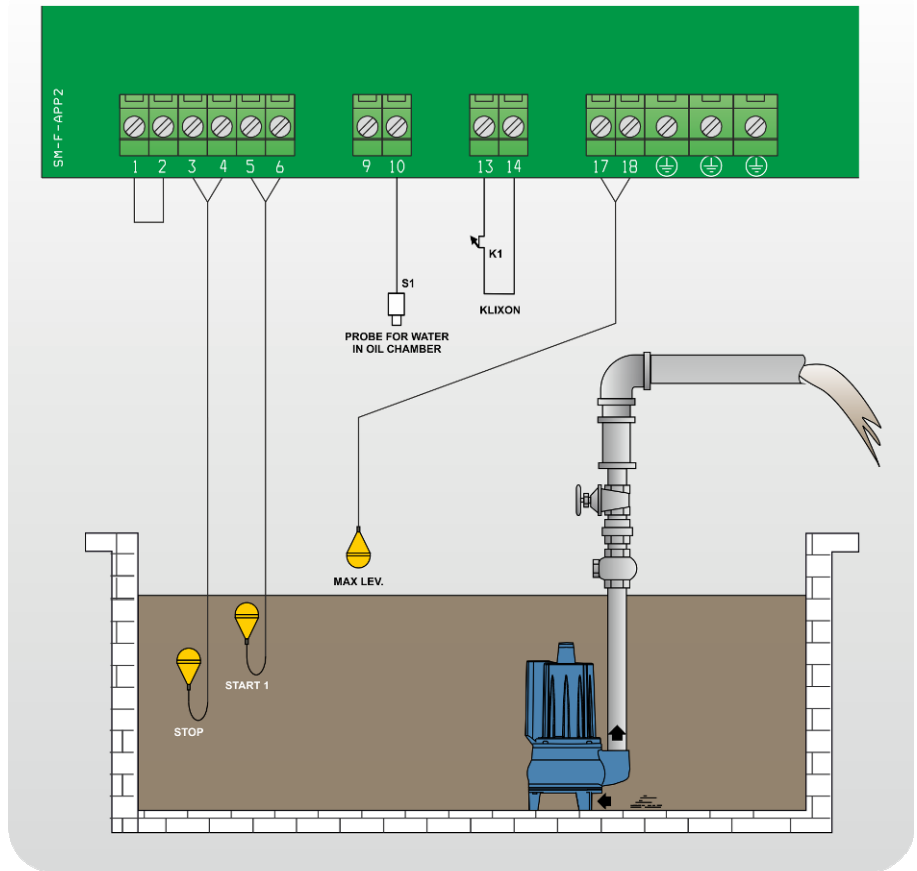

DARK [fill]

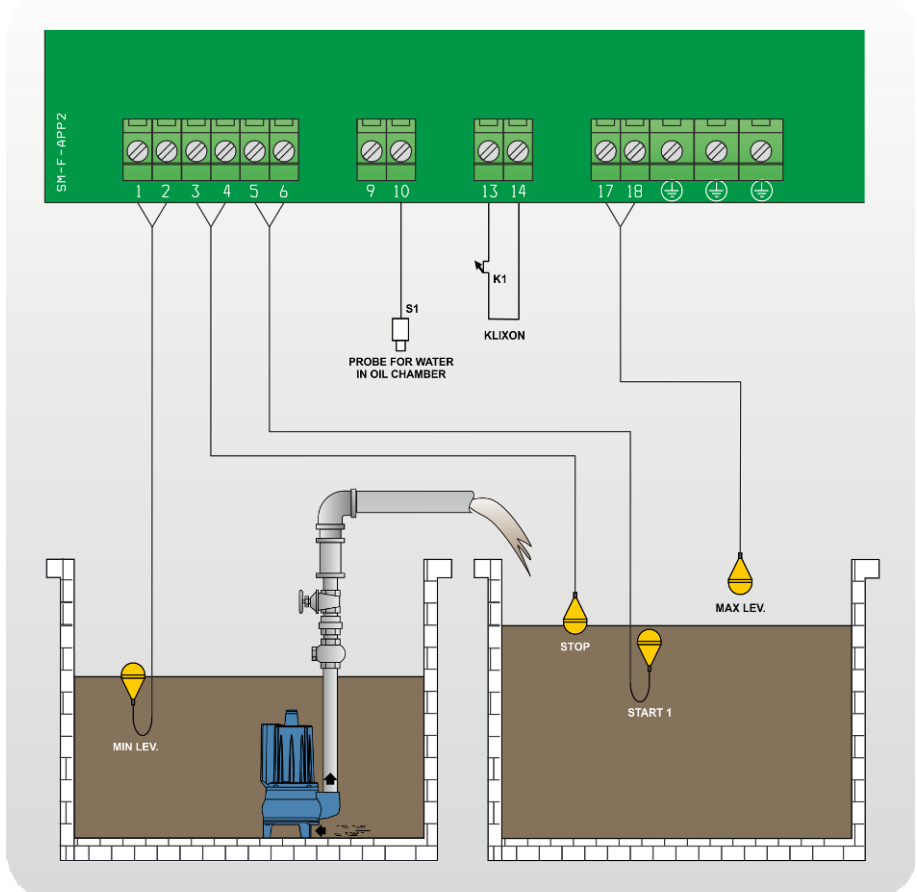

CLEAN [empty]

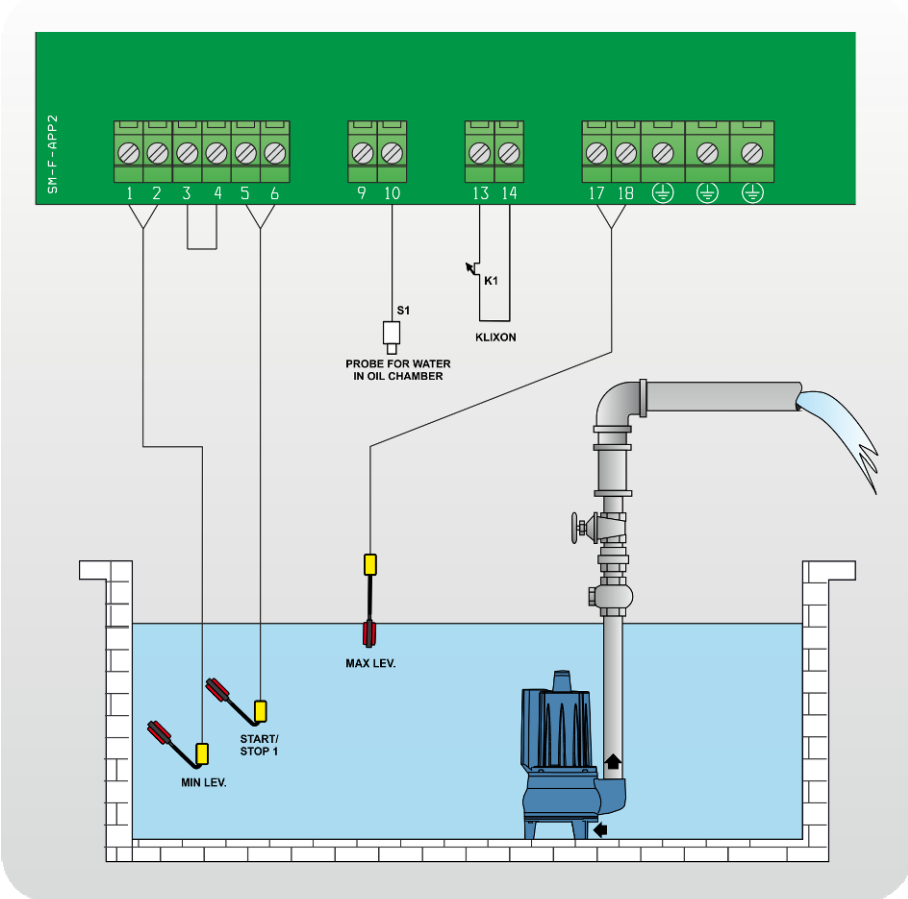

CLEAN [empty]

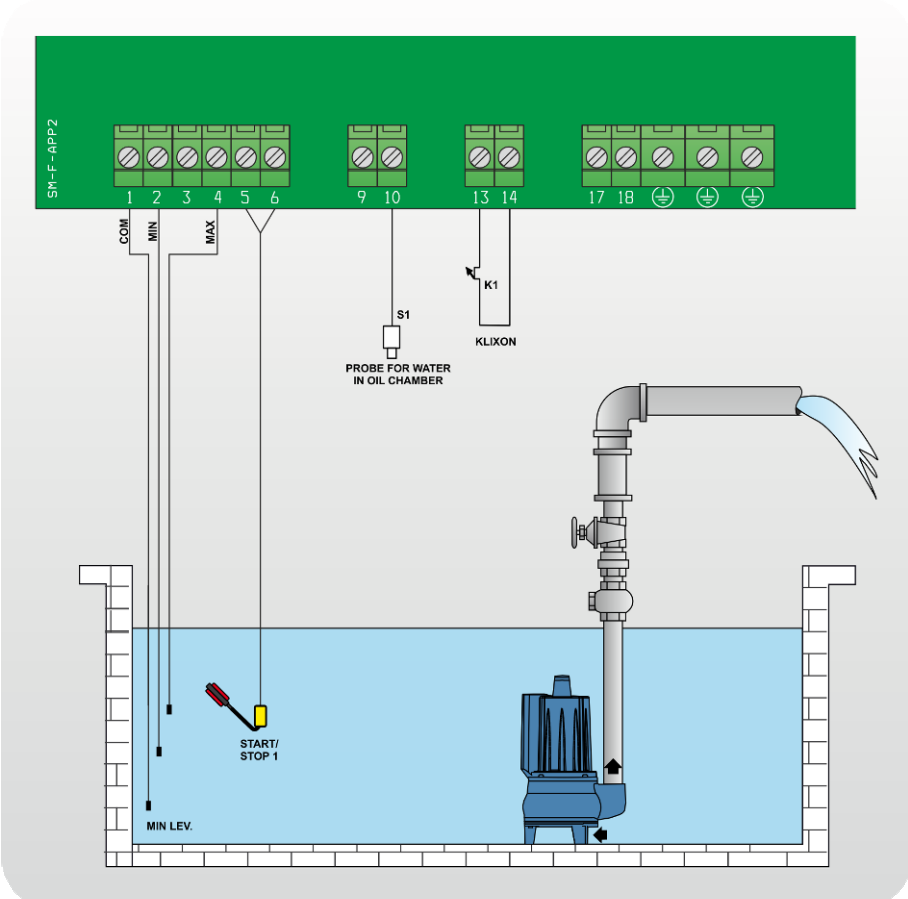

CLEAN [empty]

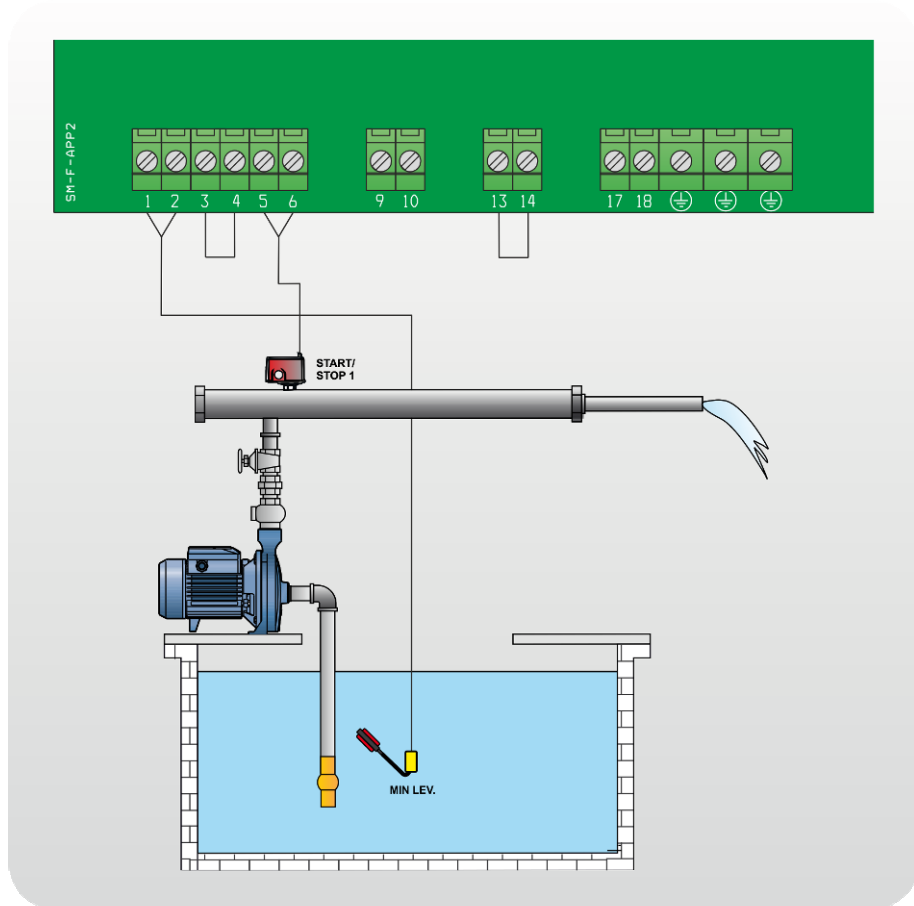

CLEAN [empty]

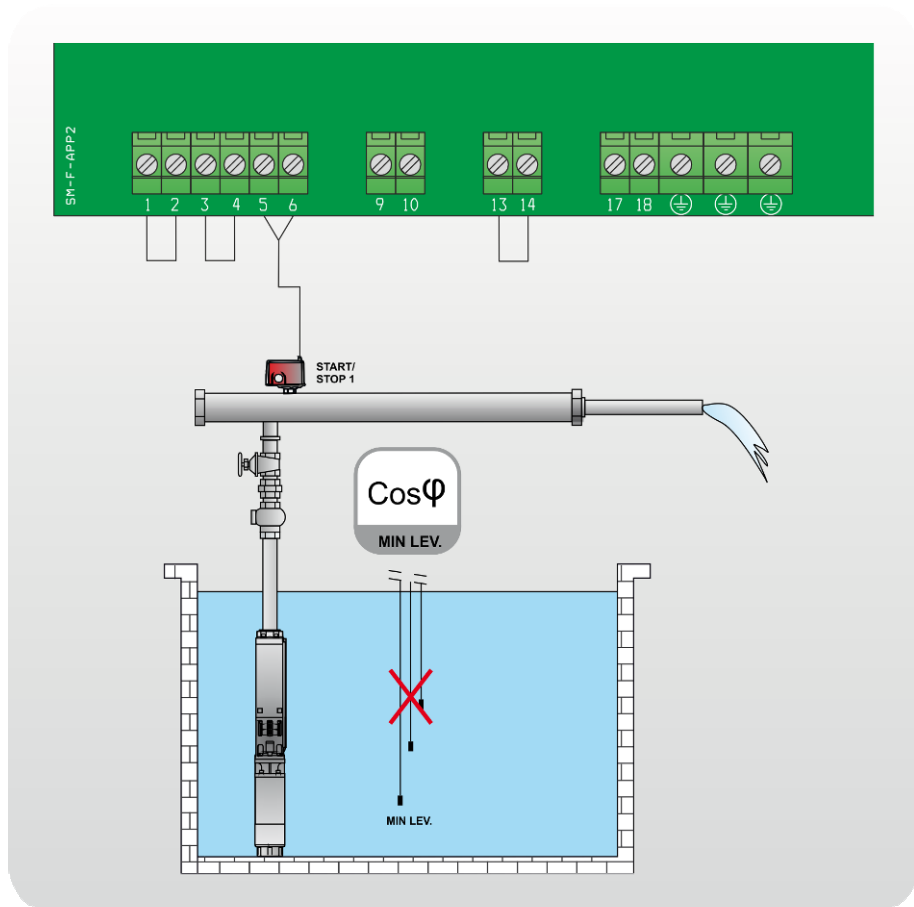

DIGIT [empty]

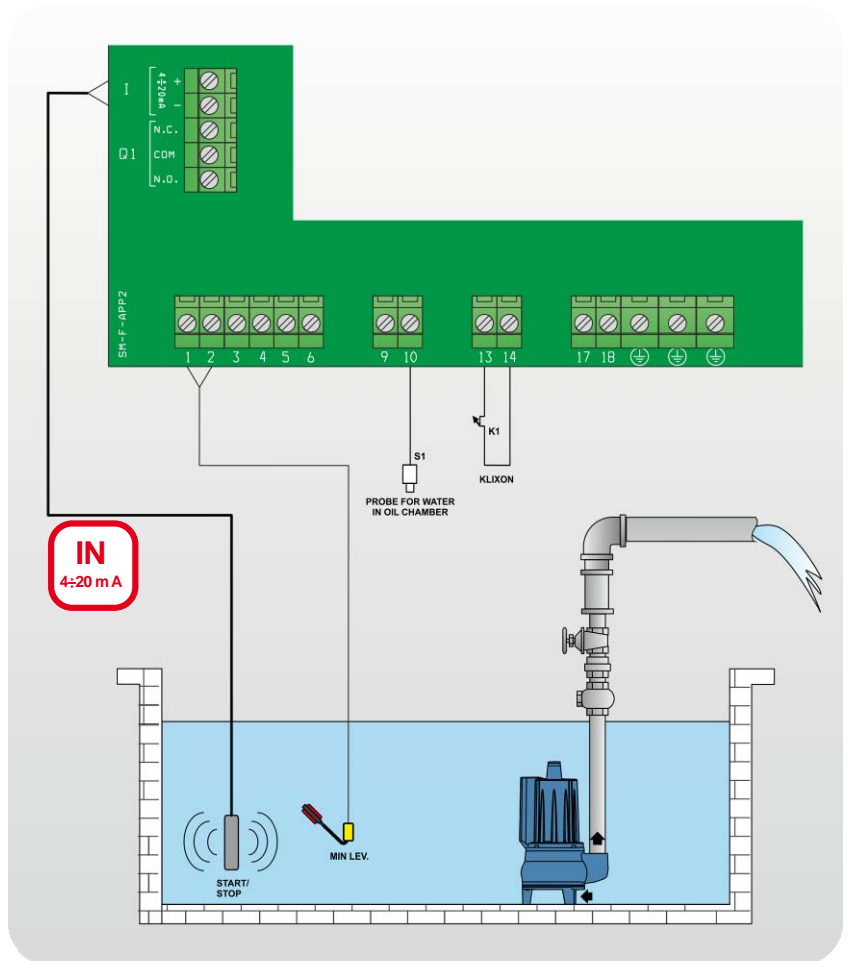

DIGIT [fill]

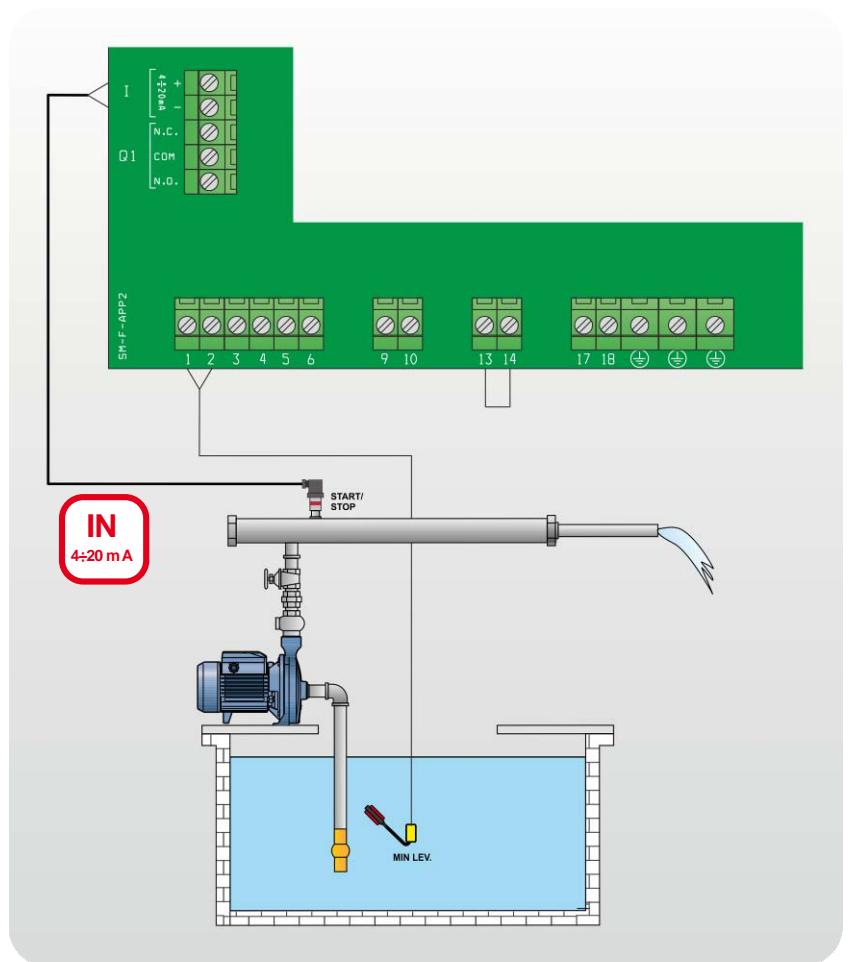

19. STOP OF THE PUMP



Motor stop may occur in the following ways:

- In "manual" by releasing the MANUAL button (after the time set in parameter "Turn-Off MANUAL ");
- In "automatic" mode when there is no consensus from the control inputs or by pressing "0" button;
- In "automatic" mode by pressing the "STOP" button from Remote-App (if active);
- Turning the main interlock switch to "0" position.

20. MAINTENANCE



XTREME¹ does not require any routine maintenance provided that their working limits are observed. Any maintenance operations must be performed by qualified and experienced personnel, in compliance with the safety regulations in force.

DANGER!

Make sure that the control panel is disconnected from the power supply before performing any maintenance operations.

21. WASTE DISPOSAL

After the control panel has been installed and started, the customer must provide for the appropriate elimination/disposal of the waste materials according to the legislation locally in force. If the control panel or parts of it must be taken out of service and dismantled, follow local regulations regarding sorted waste disposal. Refer to the appropriate recycling centres.

CAUTION: Contamination of the environment with hazardous substances such as battery acid, fuel, oil, plastic, copper, etc., may cause serious damage to the environment and endanger people's health.

22. SPARE PARTS



Always state the exact model identification number and construction number when requesting technical information or spare parts from our sales and service centre.

Use only original spare parts when replacing any faulty components.

The use of unsuitable spare parts can cause malfunctions, personal injury and damage to property.

23. CONFORMITY DECLARATION



CONFORMITY DECLARATION



The manufacturer:

FOURGROUP S.r.l.

Via E. Fermi, 8 – 35020 Polverara (PD) – ITALY

**DECLARES UNDER HIS OWN RESPONSIBILITY
THAT THE MACHINE DESCRIBED BELOW :**

XTREME¹ -M , XTREME¹ -T

ARE IN CONFORMITY WITH COMMUNITY DIRECTIVES REGARDING:

- Low voltage 2014/35/UE
- Electromagnetic compatibility 2014/30/EU
- Directive RoHS 2011/65/UE

AND AS APPLICABLE TO HARMONIZED STANDARDS:

- EN 50581
- EN 61439-1
- EN 61439-2
- EN 60204-1
- EN 55014-1
- EN 55014-2
- EN 61000-3-2
- EN 61000-3-3

Moreover Mr. Grigoletto Walter, as the legal representative of the company, is the person authorized to compile the technical documentation file.

Polverara – Italy, 07/02/2019

Technical Manager
(Grigoletto Per. Ind. Walter)

24. GENERAL CONDITIONS OF SALE

(M.COM.1.1 Rev.1 del 26/07/2012)

All sales entered into by Fourgroup S.r.l. (the Vendor) are to be governed exclusively by the following General Conditions of Sale. Any clause or condition drawn up by the Buyer shall become null and void if found to be in conflict with the following conditions.

1. Quotes, orders and order confirmation

1.1. Estimates issued by Fourgroup S.r.l., including the description, technical features and prices of the goods shall not in any case be considered as a binding sales agreement, but rather a quote. The conditions set forth in said quote shall lose all validity and effect thirty days from the time they are transmitted to the Customer, unless Fourgroup S.r.l. receives an Order from the Customer in the meantime.

1.2. The Buyer's Order must include indication of the quantity and name of the products required. Unwritten orders (required by phone or verbally) have to be confirmed with a written reply by the buyer; otherwise Fourgroup doesn't take charge of any kind of mistakes about orders proceeding.

1.3. The mere sending of the Order by the Buyer shall imply that the Buyer has read and is familiar with all these General Conditions of Sale, which shall consequently be fully accepted unconditionally and without restriction by the Parties.

1.4. Buyer's Orders only become binding for the Fourgroup S.r.l. after the latter has sent an Order Confirmation to the Buyer. The Buyer will totally accept these General Conditions of Sales, products quantity and prices, once two days have elapsed from the receiving of order confirmation even if the buyer doesn't send the same order confirmation stamped and countersigned to Fourgroup S.r.l.

1.5. Information provided in catalogues, schedules and price-lists is not binding for Fourgroup S.r.l., which reserves the right to make any modification whatever to its products and to prices thereof in view of which, the Fourgroup S.r.l. is to be considered bound only by such details as appear in the relative Order Confirmation.

1.6. Fourgroup S.r.l.'s catalogues have been drawn up with the utmost attention in order to ensure the accuracy of information, however, Fourgroup S.r.l. declines responsibility for any errors or omissions contained in the same, as the Parties are only bound by the contents of Orders, Order Confirmation and these General Conditions of Sale.

2. Conclusion of the contract

2.1. The contract of sale shall only be considered as concluded with Fourgroup S.r.l.'s explicit acceptance thereof by means of the Order Confirmation issued by Fourgroup S.r.l..

3. Prices

3.1. The contract prices are those set forth in the Order Confirmation, and are to be considered as being for merchandise made ready by Fourgroup S.r.l. "ex-works" (EXW), according to Incoterms (International Commerce Terms).

3.2. Any amendment to the contract requested by the Buyer after its conclusion shall be null and void unless accepted in writing by Fourgroup S.r.l., specifying new terms of delivery, prices and terms of payment where applicable.

4. Delivery dates

4.1. The terms of delivery stated on the Order Confirmation are indicative, without prejudice to Fourgroup S.r.l.'s undertaking to observe the same as far as possible.

4.2. In any event, given the indicative nature of the terms of delivery, Fourgroup S.r.l. shall in no circumstances be held responsible for any direct or indirect damage to the Buyer on account of late delivery, unless shipment date has been guaranteed in a written way by Fourgroup Srl accepting an agreement with daily penalty clauses in case of delay.

4.3. Fourgroup S.r.l. is entitled to postpone the delivery deadline or suspend the delivery of the contractual material, at its unchallengeable discretion:

a) should the Buyer fail to observe the conditions of payment established or be late in fulfilling its contractual obligations (such as, by way of a non-limiting example, the sending of advances, granting of guarantees, issue and presentation of credit instruments and other financial fulfilments) including those relating to previous relations with Fourgroup S.r.l.;

b) force majeure and like instances, such as, by way of a non-limiting example strikes, lock-outs or abstention from labour, epidemic, war, requisition, fire, flood, processing incidents and stoppages and/or delays in transportation, blackout or inadequacy of power supplies and any other event that cannot be attributed to Fourgroup S.r.l. or its suppliers;

c) failure on the part of the Buyer to provide Fourgroup S.r.l., in good time, with any information it has undertaken to provide and necessary for the supply and/or materials to be delivered.

d) when amendments are made to the Order, even with Fourgroup S.r.l.'s acceptance;

e) in the event of difficulties in procurement of raw materials.

In cases in which suspension of supplies or extension in delivery deadlines are due to causes that can be referred in any way to the Buyer (such as, by way of a non limiting example, those cases set forth in the previous paragraph under points a, c and d), Fourgroup S.r.l. shall be entitled to claim compensation from the Buyer for the damage suffered.

4.4. Delayed delivery shall not in any case entitle the Buyer to claim for compensation for damage.

5. Suspended or cancelled orders

5.1. In the event of the Buyer's suspending or cancelling an order, Fourgroup S.r.l. reserves the right to invoice the Buyer in respect of:

a) the cost, calculated pro-rata, of materials utilized and of work accomplished in filling the order thus far. The merchandise in this instance remaining at the Buyer's disposal;

b) increased expenditure ensuing to Fourgroup S.r.l. from the Buyer's failure to settle, in addition to 20% of the difference between the order sum-total and the amount previously arrived at by the application of point a).

6. Deliveries

6.1. Delivery is usually understood as ex-works (EXW) at Fourgroup S.r.l.'s premise.

6.2. Specifically, delivery may be said to have taken place, to all intents and purposes, with the sending of notice (which may simply take the form of an invoice) either to the effect that merchandise is available for collection by the Buyer, or to the effect that it has been handed over to the freight company.

6.3. Once notice has been received that the goods are ready, the Buyer must swiftly indicate the name of the freight company, when appointed by the same, which will collect the goods. The Buyer must also arrange insurance cover for transportation.

6.4. In case of the late collection of merchandise made ready by Fourgroup S.r.l. for any reason whatsoever not attributable to lack of goodwill on the part of Fourgroup S.r.l., the goods shall be considered delivered starting from the communication that the goods were ready for collection, with the following consequences:

a) Fourgroup S.r.l. shall be entitled to issue the relative invoice and claim fulfilment of the terms of payment established;

b) Fourgroup S.r.l. may package, transport or store the material at the Buyer's expense, without prejudice to its right to claim for any damage suffered, including the costs for warehousing, keeping and storage of the goods.

7. Payment

7.1. Payments must be remitted to Fourgroup S.r.l.'s place of business, and made in accordance with such conditions as are agreed; any remittance made at location or in manner differing therefrom, may not be deemed valid and shall consequently not have a redeeming effect for the Buyer

7.2. In the event of late payment at the agreed deadlines, Fourgroup S.r.l. shall be entitled to charge penalty interest pursuant to Legislative Decree no. 231 of 9th October 2002.

7.3. Any claims or disputes give no right to the Buyer to suspend or delay the payment of invoices.

7.4. The issue of bills of exchange, IOUs, drafts, cheques or any other form of payment or guarantee shall not cause any amendment to the contract or any of the contract clauses (specifically, it shall not change the place of jurisdiction in the case of a dispute) and shall be exclusively considered as aimed at facilitating the definition of the relationship, without having any novation effect.

7.5. Advance payment to Fourgroup S.r.l. shall always be non-interest bearing.

8. Freightforwarding

8.1. All transactions regarding transport, insurance, customs and excise, handling, and delivery are at the care, expense and risk of the Buyer, whose

responsibility it is both to check the merchandise upon arrival and to make any claim against the freight company by direct approach, even where merchandise has been dispatched carriage-paid.

8.2. In those cases where Fourgroup S.r.l.'s transport facilities are utilized for shipping merchandise, the latter is to be dispatched, ex-works at best, with the Buyer duly assuming total responsibility thereof.

9. Claims

9.1. Any claim or contestation on the part of the Buyer with regard to merchandise supplied, must be forwarded in writing to Fourgroup S.r.l. within 8 working days of the date of delivery of the goods and sent to Fourgroup S.r.l.

9.2. In the event of claims for tampering with or shortage of goods, the Buyer shall promptly notify the freight company in writing at the time the goods are received.

10. Warranty

10.1. Fourgroup S.r.l. guarantees the good operation of the standard Fourgroup S.r.l. products for 12 months from the date of their dispatch. This warranty period could be extended and become 18 months if the goods have stand in our retailer's warehouses.

10.2. The warranty is limited to repair or replacement of parts at Fourgroup S.r.l.'s unchallengeable discretion, forwarded carriage-paid to an address specified Fourgroup S.r.l., which show recognizable defects due to defective materials or manufacturing. The parts replaced remain property of Fourgroup S.r.l..

10.3. The warranty does not cover parts that are subject to natural wear or deterioration (such as, by way of a non-limiting example, seal rings, fuse, filters, warning light).

10.4. No other compensation of any kind is envisaged by the warranty, neither can there be any question of claims for damages of any kind, direct or indirect, (including by third parties), even in respect of temporarily suspended use of the merchandise purchased. Examination of such defects and the causes thereof is to be carried out at one of Fourgroup S.r.l.'s factories, by Fourgroup S.r.l..

10.5. Expenses relating to operations (such as, for example, labour, dismantling, reassembly, transport, board and lodgings) by Fourgroup S.r.l.'s personnel to outside locations for the purpose, are chargeable to the Buyer, even in case the right to repairs under warranty has been acknowledged. Fourgroup S.r.l. will be chargeable only for the costs of replaced parts and the time needed to replace them.

10.6. The warranty ceases to be effective for products stored, installed utilized or maintained in a negligent or improper manner, i.e. not in accordance to Fourgroup S.r.l.'s instructions, or modified and/or repaired in any way whatsoever, or entirely or partially disassembled

10.7. The warranty also excludes damages and/or defects and/or abnormalities deriving from external components (such as, by way of a non-limiting example lightnings, atmospheric discharge etc.).

10.8. The warranty mentioned in article 10 replaces and excludes any other form of warranty, even legal.

10.9. The Buyer's entitlement to the warranty mentioned in this article shall be null and void in the case of non-performance of even just one of the contractual obligations assumed, specifically as regards the conditions of payment.

10.10. Any repairs under warranty and/or not under warranty are to be required in writing by the Buyer to Fourgroup Srl, writing the serial number of the product, defect claimed, mentioning purchasing document.

10.11. For replaced or repaired parts and for these alone, the warranty period recommences and void the same day of the expiry date of the warranty of the product or of electrical equipment.

11. Liability

11.1. Should Fourgroup S.r.l. be liable for faulty products, the compensation shall not in any case exceed the purchase price of the same faulty products.

11.2. Fourgroup S.r.l. shall not in any case be liable for indirect damage such as, for example, loss of clientele, turnover, production, profit, image or any damage to the Buyer for any action taken against it by third parties.

11.3. Fourgroup S.r.l. shall not in any case be liable when product defects are due, by way of a non-limiting example, to:

- a) improper, incorrect or excessive use;
- b) improper, incorrect or inadequate maintenance
- c) product use that is unusual or contrary to Fourgroup S.r.l.'s warnings or, in any case, different to its intended use;
- d) use of product with non-original components;
- e) improper conservation

12. Applicable law, jurisdiction and place of jurisdiction

12.1. Any dispute concerning the stipulation, validity, interpretation, execution and termination of this agreement shall be governed by Italian Law and the court of Padova shall have sole jurisdiction, with the exclusive jurisdiction of the Italian judge, with the explicit exclusion of any other court.

13. Proprietorship of goods. Indemnity

13.1. The property of the goods forming the subject of this sale is of Fourgroup S.r.l. and shall be transferred to the Buyer only upon full payment of the agreed price by the Buyer pursuant to articles 1523 f. of the Italian Civil Code.

13.2. Non-payment within the established terms of even just one instalment amounting to over one eighth of the sale price or non-payment of two instalments regardless of the sum of the same, according to the agreed terms, shall automatically invalidate the Buyers' acceleration clause, with Fourgroup S.r.l. consequently being entitled to full and immediate payment, in a single settlement of the full residual credit.

13.3. Furthermore, when preferred by Fourgroup S.r.l., it shall be entitled to terminate the agreement and consequently obtain immediate return of the material delivered, withhold as indemnity, all the instalments paid and demand payment of the instalments expired and 3/5 (three fifths) of those yet to expire, without prejudice to compensation for further damage.

14. Form of the agreement

14.1. This agreement represents the only negotiation instrument governing relations between the Parties.

14.2. Any agreements to derogate, amend and/or supplement these General Conditions of Sale shall be stipulated and proven in writing.

14.3. The Buyer hereby agrees to have received and carefully examined the technical documentation provided by Fourgroup S.r.l., drawn up in Italian and English, regarding the material acquired.

15. Invalid clauses

15.1. The Parties hereby explicitly agree that the invalidity of one or more provisions of this agreement shall not affect the validity of the agreement as a whole.

The Buyer

Pursuant to article 1341, subsection 2 of the Italian Civil Code, the Parties hereby declare to have negotiated, carefully read and consequently to unconditionally approve the following clauses of these General Conditions of Sale:

1. exclusion of Fourgroup S.r.l.'s responsibility in the preparation of catalogues;
2. conclusion of the agreement;
3. exoneration from responsibility for late delivery; Fourgroup S.r.l.'s right to suspend delivery; Buyer's renunciation of termination of contract and damage compensation for delay in performance by Fourgroup S.r.l.;
4. solution for suspension or cancellation of orders;
5. renunciation to suspend or delay payment; penalty clause;
6. term for complaints and expiry;
7. warranty: discipline and limitations;
8. applicable law, jurisdiction, and place of jurisdiction;
9. proprietorship and indemnity;

The Buyer

Please note that the above mentioned General Conditions of Sale can be consulted on and downloaded from our website www.fourgroup.it