



FN SERIES 50 HZ

END SUCTION CENTRIFUGAL PUMPS ACCORDING TO EN 733



INDEX

Family curves.....	4
Pump identification code.....	4
Motors specifications	5
Motors for FNC.....	5
Motors for FNS.....	6
Mechanical seal specifications	9
Spare parts.....	10
FNC.....	10
FNS.....	11
FNE.....	12
Technical data and dimensions	13
FNC.....	14
FNS.....	16
FNE.....	18
Hydraulic performance at 50 Hz.....	21
FNC/FNS - Hydraulic performance at 50 Hz.....	22
FNE - Hydraulic performance at 50 Hz.....	23
FNC/FNE 32 - Performance curves at 50 Hz.....	24
FNC/FNS/FNE 32 - Performance curves at 50 Hz.....	26
FNC/FNE 40 - Performance curves at 50 Hz.....	28
FNC/FNS/FNE 40 - Performance curves at 50 Hz.....	30
FNC/FNE 50 - Performance curves at 50 Hz.....	32
FNC/FNS/FNE 50 - Performance curves at 50 Hz.....	34
FNC/FNS/FNE 65 - Performance curves at 50 Hz.....	36
FNS/FNE 65 - Performance curves at 50 Hz.....	39
FNC/FNS/FNE 80 - Performance curves at 50 Hz.....	40
FNS/FNE 80 - Performance curves at 50 Hz.....	41

END SUCTION CENTRIFUGAL PUMPS ACCORDING TO EN 733

INTRODUCTION

- The End suction centrifugal electric pumps are designed to pump clean liquids, without abrasives and suspended solids, non - explosive environments.
- Maximum liquid temperature:
 - up to 90 °C for domestic use
 - up to 120 °C for industrial use

STANDARD REFERENCE:

- ErP 547/2012 (MEI > 0,4)
- 640/2009 (Motors efficiency class IE3)
- UNI EN 733 (DIN 24255)

FNC - EXTENDED SHAFT PUMPS

- Close-coupled electric pumps with extended shaft motor.

PUMP SPECIFICATION

- Flow: up to 180 m³/h at 50 Hz
- Head: up to 90 m at 50 Hz
- Maximum working pressure: PN10

MATERIALS AND BUILDING FEATURES

- Pump body / Mechanical seal housing / Motor bracket: Cast-iron GG20 with anti-corrosive coating
- Suction/delivery ports: according to standard EN1092-2
- Impeller: Cast-iron GG20 with cataphoresis coating
- Pump shaft: Stainless steel AISI 304
- Mechanical seal: Carbon / Ceramic / NBR

MOTOR SPECIFICATION

- Asynchronous squirrel cage-type motor
- External ventilation
- Incorporated motor protection and capacitor always on, for single-phase motors
- The motor protection for three-phase motors must be installed by the customer (Is recommended to use an equipment compliant with current standards)
- Efficiency class: IE3
- Insulation class: F
- Service class: S1
- Protection degree: IP 54



FNS - STUB SHAFT PUMPS

- Rigid-coupled with a bracket, an adapter and a rigid coupling keyed to the standard motor shaft extension.

PUMP SPECIFICATION

- Flow: up to 240 m³/h at 50 Hz
- Head: up to 100 m at 50 Hz
- Maximum working pressure: PN10

MATERIALS AND BUILDING FEATURES

- Pump body / Mechanical seal housing / Motor bracket: Cast-iron GG20 with anti-corrosive coating
- Suction/delivery ports: according to standard EN1092-2
- Impeller: Cast-iron GG20 with cataphoresis coating
- Pump shaft: Stainless steel AISI 304
- Mechanical seal: Carbon / Ceramic / NBR

MOTOR SPECIFICATION

- Asynchronous squirrel cage-type motor
- External ventilation
- The motor protection for three-phase motors must be installed by the customer (Is recommended to use an equipment compliant with current standards)
- Efficiency class: IE3
- Insulation class: F
- Service class: S1
- Protection degree: IP 55
- PTC 155 °C as standard



FNE - BARE SHAFT PUMPS

- Bare shaft version suitable to be coupled with a standard electric motor.

PUMP SPECIFICATION

- Flow: up to 240 m³/h at 50 Hz
- Head: up to 100 m at 50 Hz

MATERIALS AND BUILDING FEATURES

- Pump body / Mechanical seal housing / Motor bracket: Cast-iron GG20 with anti-corrosive coating
- Suction/delivery ports: according to standard EN1092-2
- Impeller: Cast-iron GG20 with cataphoresis coating
- Pump shaft: Stainless steel AISI 304
- Mechanical seal: Carbon / Ceramic / NBR

ON REQUEST

- Version with motor, coupling and base



FAMILY CURVES

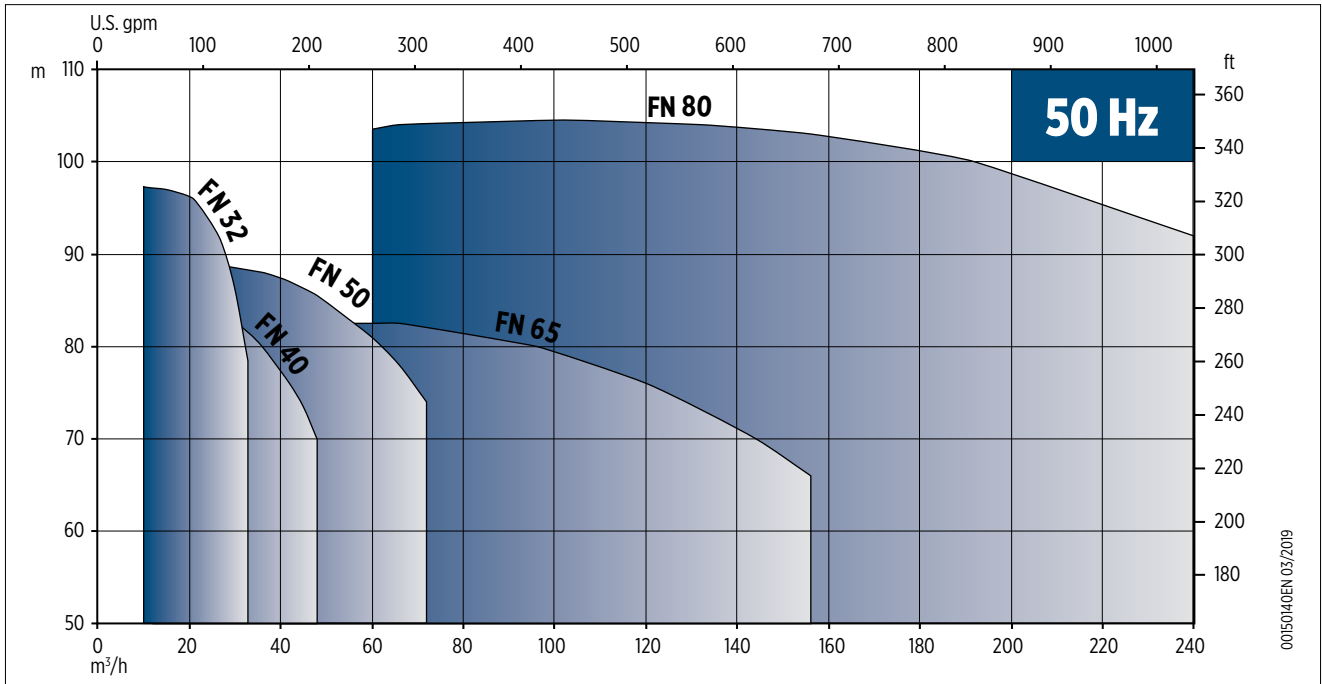

00150140EN 03/2019

PUMP IDENTIFICATION CODE

32 - 125 / 011 M 5 P0 230 V

- Special versions
- Voltage
- Mechanical seal type
- Frequency: 5 (50Hz); 6 (60Hz)
- M (single-phase); T (three-phase)
- Motor size
- Impellers diameter
- Delivery port
- FNC: Close-coupled model
- FNS: Stub shaft model
- FNE: Bare shaft model

00040059EN 02/2019



MOTORS SPECIFICATIONS

MOTORS FOR FNC

FEATURES

- Protection degree: IP54
- Max. ambient temperature: 40 °C
- Insulation class: F

SINGLE-PHASE VERSION

- Standard voltage: 230 V
- Capacitor inside terminal box

Electric pump model	Power P ₂		V nom [V]	μF	cos φ	I max [A]	P ₁ [kW]	rpm [min ⁻¹]
	[kW]	[HP]						
FNC 32-125	1.1	1.5	1 x 230	31.5	0.94	7.6	1.8	2900
	1.5	2	1 x 230	40	0.97	11	2.3	2900
FNC 32-160	2.2	3	1 x 230	50	0.98	13	3	2900
FNC 40-125	1.5	2	1 x 230	40	0.97	12.5	2.4	2900
	2.2	3	1 x 230	50	0.98	13	3	2900
FNC 50-125	2.2	3	1 x 230	50	0.98	12.5	3	2900

THREE-PHASE VERSION

- High efficiency three-phase motors IE3
- Standard voltage: up to 4 kW 230/400 V, 400/690 V from 5.5 kW

Electric pump model	Power P ₂		V nom [V]	η	cos φ	I max [A]	I min [A]	P ₁ [kW]	rpm [min ⁻¹]
	[kW]	[HP]							
FNC 32 125	1.1	1.5	230/400	82.7	0.75	4.6	2.6	1.4	2900
	1.5	2	230/400	84.2	0.75	6	3.4	1.7	2900
FNC 32 160	2.2	3	230/400	86.5	0.79	7.9	4.5	2.4	2900
	3	4	230/400	87.1	0.78	12.2	7	3.7	2900
FNC 32 200	4	5.5	230/400	88.1	0.81	13	7.5	5.4	2900
	5.5	7.5	400/690	89.2	0.88	10.5	6.1	6.3	2900
FNC 32 250	7.5	10	400/690	90.1	0.89	14.5	8	8.5	2900
	9.2	12.5	400/690	90.7	0.86	18.1	10.4	10.2	2900
FNC 32 250	11	15	400/690	91.2	0.84	21.8	12.7	12.9	2900
	15	20	400/690	91.9	0.86	28.5	16.6	15.3	2900
FNC 40 125	1.5	2	230/400	84.2	0.75	6.3	3.6	2.1	2900
	2.2	3	230/400	86.5	0.79	9.1	5.2	2.7	2900
FNC 40 160	3	4	230/400	87.1	0.78	12.1	7	4.1	2900
	4	5.5	230/400	88.1	0.81	13	7.5	5.3	2900
FNC 40 200	5.5	7.5	400/690	89.2	0.88	10.9	6.4	7.6	2900
	7.5	10	400/690	90.1	0.89	14.5	8	9.5	2900
FNC 40 250	11	15	400/690	91.2	0.84	21.8	12.7	14.3	2900
	15	20	400/690	91.9	0.86	30.1	17.5	18	2900
FNC 50 125	2.2	3	230/400	86.5	0.79	10.1	5.8	3.2	2900
	3	4	230/400	87.1	0.78	12.2	7	4.1	2900
FNC 50 160	4	5.5	230/400	88.1	0.81	13	7.5	4.5	2900
	5.5	7.5	400/690	89.2	0.88	10.9	6.4	5.9	2900
FNC 50 200	7.5	10	400/690	90.1	0.89	14.5	8	7.8	2900
	9.2	12.5	400/690	90.7	0.86	17.1	9.8	10.5	2900
FNC 50 250	11	15	400/690	91.2	0.84	21.4	12.4	11.9	2900
	15	20	400/690	91.9	0.86	28.1	16.3	13.9	2900
FNC 50 250	15	20	400/690	91.9	0.86	30.5	17.7	19.9	2900
	18.5	25	400/690	92.4	0.86	34	19.7	22.8	2900
	22	30	400/690	not available					available from June 2019

Electric pump model	Power P ₂		V nom [V]	η	cos φ	I max [A]	I min [A]	P ₁ [kW]	rpm [min ⁻¹]
	[kW]	[HP]							
FNC 65 125	5.5	7.5	400/690	89.2	0.88	10.9	6.4	7.2	2900
	7.5	10	400/690	90.1	0.89	13.5	7.8	7.8	2900
FNC 65 160	9.2	12.5	400/690	90.7	0.86	17.6	10.1	10.3	2900
	11	15	400/690	91.2	0.84	21.4	12.4	12.1	2900
	15	20	400/690	91.9	0.86	28.5	16.6	13.7	2900
FNC 65 200	15	20	400/690	91.9	0.86	32	18.6	19.6	2900
	18.5	25	400/690	92.4	0.86	34	19.7	22.2	2900
	22	30	400/690	not available	available from June 2019				
FNC 80 160	11	15	400/690	91.2	0.84	21.4	12.4	13.8	2900
	15	20	400/690	91.9	0.86	28.1	16.3	16.4	2900
	18.5	25	400/690	92.4	0.86	34	19.7	19	2900
	22	30	400/690	not available	available from June 2019				

MOTORS FOR FNS

FEATURES

- AEG Lafert motors
- Protection degree: IP55
- Max. ambient temperature: 40 °C
- Insulation class: F
- B35 size

THREE-PHASE MOTORS

- High efficiency three-phase motors IE3
- The Standard design includes the following basic features to give a high level of flexibility:
 - Multi Mount Construction for an easy change of terminal box position
 - Terminal box rotates by 90° to allow cable entry from any direction
 - Easy-to-change flanges with over-sized and smaller-sized dimensions
 - Designed for oil seal at drive end to be mounted
- Standard voltage: up to 4 kW 230/400 V, 400/690 V from 5.5 kW

Power P ₂		IEC dim.	Design	I _N [A]			400 V - 50 Hz					
[kW]	[HP]			Δ 400 V	Y 690 V	rpm [min ⁻¹]	M _N [Nm]	η %	cos φ	I _A /I _N	M _A /M _N	Weight [Kg]
5,5	7,5	B35	132	10.2	5.9	2920	18.0	89.2	0.90	8.9	3.0	46.0
7,5	10	B35	132	14.4	8.3	2910	24.6	90.1	0.92	8.9	3.0	53.0
9,2	12,5	B35	132	16.5	9.6	2930	30.0	90.7	0.89	10.1	3.7	58.0
11	15	B35	160	19.9	11.5	2950	35.6	91.2	0.89	9.1	4.0	57.8
15	20	B35	160	26.8	15.5	2940	48.7	91.9	0.89	9.7	4.7	88.9
18,5	25	B35	160	33	19.1	2950	59.9	92.4	0.88	10.7	4.6	104
22	30	B35	160	39.4	22.8	2950	71.3	92.7	0.87	10.4	4.5	104
30	40	B35	200	52.7	30.5	2925	97.9	93.3	0.88	6.7	2.4	234
37	50	B35	200	63.3	36.6	2930	120.6	93.7	0.90	6.3	2.3	250
45	60	B35	200	78.5	45.4	2930	146.7	94.0	0.88	6.9	2.3	322
55	75	B35	250	93.5	54	2940	178.6	94.3	0.88	8.0	2.3	420
75	100	B35	280	124.5	72	2940	243.6	94.7	0.92	8.0	2.2	630

LAFERT MOTORS SPARE PARTS

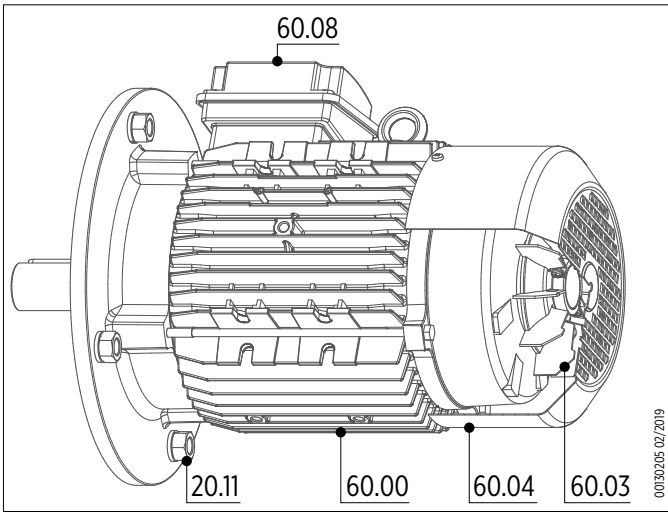

Ref. No	Parts description
20.11	Lifting eyelets and bolts
60.00	Motor assembly
60.03	Fan
60.04	Fan cover and screws
60.08	Terminal box cover and base

NEW INTERNATIONAL EFFICIENCY CLASSES OF MOTORS – IE CODE

New International Efficiency classes of motors – IE code

The new IEC 60034-30:2008 defines the efficiency classes of motors worldwide.

IE2 = High Efficiency (comparable to EFF1)

IE3 = Premium Efficiency

The efficiency levels according to IEC 60034-30 are measured based on the test methods defined in IEC 60034-2-1:2007.

The IEC 60034-30 only defines requirements of efficiency classes and aims to create provisions for international consistency. It does not define which motors must be supplied with which efficiency level. This is subject to respective regional legislation.

POWER [kW]	IE2 code Standard Efficiency			IE3 code Standard Efficiency		
	2 poles	4 poles	6 poles	2 poles	4 poles	6 poles
0.75	77.4	79.6	75.9	80.7	82.5	78.9
1.1	79.6	81.4	78.1	82.7	84.1	81
1.5	81.3	82.8	79.8	84.2	85.3	82.5
2.2	83.2	84.3	81.8	85.9	86.7	84.3
3	84.6	85.5	83.3	87.1	87.7	85.6
4	85.8	86.6	84.6	88.1	88.6	86.8
5.5	87	87.7	86	89.2	89.6	88
7.5	88.1	88.7	87.2	90.1	90.4	89.1
11	89.4	89.8	88.7	91.2	91.4	90.3
15	90.3	90.6	89.7	91.9	92.1	91.2
18.5	90.9	91.2	90.4	92.4	92.6	91.7
22	91.3	91.6	90.9	92.7	93	92.2
30	92	92.3	91.7	93.3	93.6	92.9
37	92.5	92.7	92.2	93.7	93.9	93.3
45	92.9	93.1	92.7	94	94.2	93.7

Efficiency values according to IEC 60034-30:2008
Efficiency standard calculation: IEC 60034-2-1:2007

NOISE

The noise level of an electrical machine is determined by measuring the sound pressure level in accordance with curve A of the sound level meter to EN 60651 and is indicated in dB (A). The permitted noise levels of electrical machines are fixed in EN 60034-9 (IEC 34-9). The noise level of the motors is below these limit values. Structure-borne sound measurements are carried out in an anechoic testing chamber to EN 21680-ISO 1680. The speed is corresponding to a main frequency of 50 Hz and the number of poles.

Noise levels

The noise values listed below refer to 50 Hz at rated voltage with a tolerance of up to +3 dB (A). Values for pole-changing motors are available on request. For 60 Hz supply, the values are 3-5 dB (A) higher. Sound pressure level (L_{pA}) and sound power level (L_{WA}) refers to three-phase motors with single-speed, dimensions and output ratings as per IEC 60072.

IEC Dimension	2 poles		4 poles	
	L _{WA}	L _{pA}	L _{WA}	L _{pA}
56	57	48	47	38
63	58	49	47	38
71	61	52	51	42
80	72	60	60	48
90	74	62	61	49
100	78	66	62	50
112	80	68	65	53
132	81	72	71	59
160	87	74	75	62
180	90	77	78	66
200	91	78	80	68
225	92	80	88	76

MECHANICAL SEAL SPECIFICATIONS

(in accordance with EN 12756)

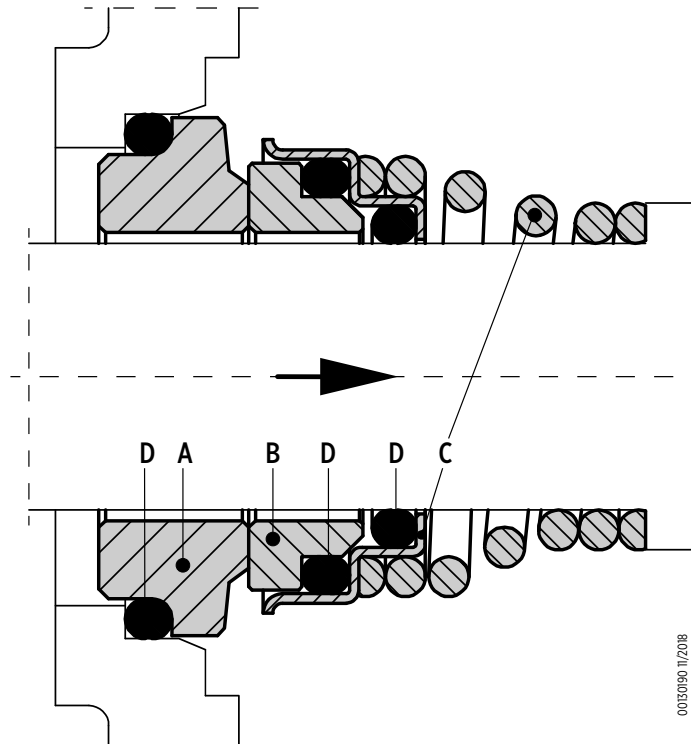

STANDARD VERSION

Model	Type				Position				Temperature [° C]
					Stationary part A	Rotating part B	Other components C	Elastomers D	
P0	V	B	G	P	Ceramic	Graphite	AISI 316	NBR	-10 ÷ +90

AVAILABLE ON REQUEST

Model	Type				Position				Temperature [° C]
					Stationary part A	Rotating part B	Other components C	Elastomers D	
E1	Q	B	G	E	Silicon carbide	Graphite	AISI316	EPDM	-20 ÷ +120
E5	U	U	G	E	Tungsten carbide	Tungsten carbide	AISI316	EPDM	-20 ÷ +120
E7	Q	U	G	E	Tungsten carbide	Silicon carbide	AISI316	EPDM	-20 ÷ +120
V4	Q	B	G	V	Silicon carbide	Graphite	AISI316	FKM	-20 ÷ +120
V6	U	U	G	V	Tungsten carbide	Tungsten carbide	AISI316	FKM	-20 ÷ +120
V8	Q	U	G	V	Tungsten carbide	Silicon carbide	AISI316	FKM	-20 ÷ +120

Type	Material
B	Graphite
E	EPDM
G	AISI 316
Q	Silicon carbide
V	FKM
U	Tungsten carbide

Diameter mechanical seal shaft - standard EN 12756		E1	V4	E7	V8	E5	V6
Motor size [kW]	Shaft diameter [mm]	QBGE	QBGV	QUGE	QUGV	UUGE	UUGV
1.1 ÷ 4	20	•	•	•	•	-	-
5.5 ÷ 7.5	24	•	•	•	•	-	-
9.2 ÷ 22	30	•	•	•	•	-	-
30 ÷ 75	40	-	-	-	-	•	•

• = Available
 - = Not available

SPARE PARTS

FNC

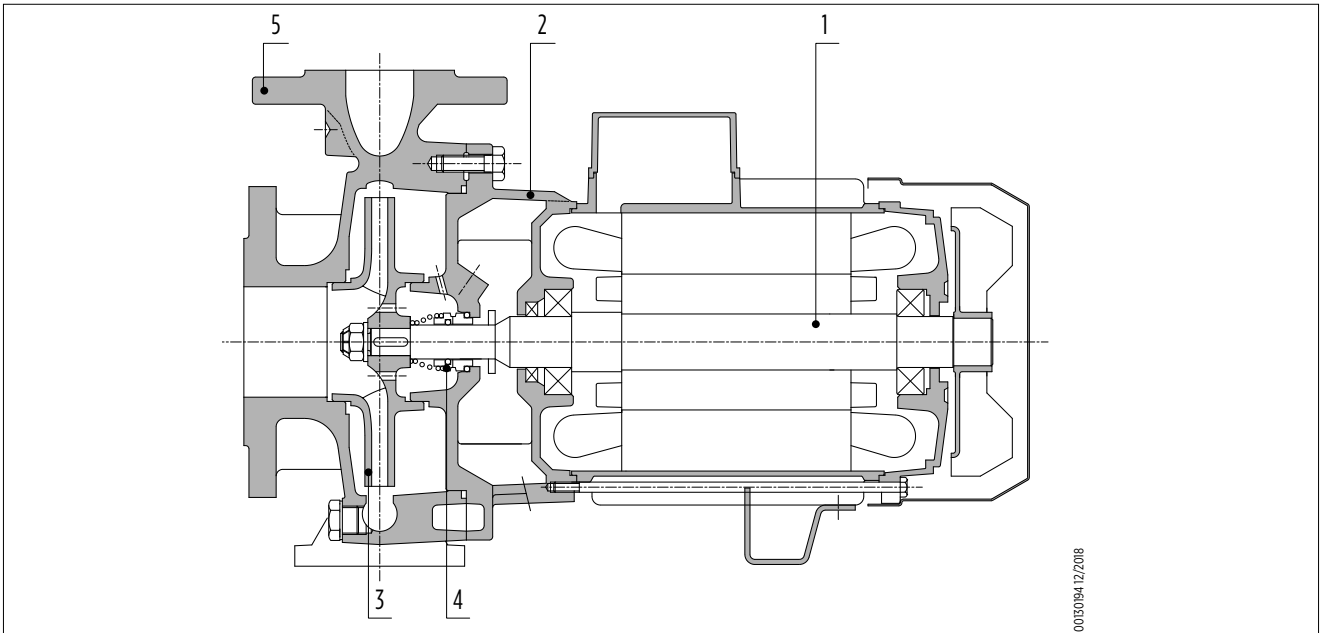

0035094.12/08

Ref. No	Parts description	Material
1	Pump shaft (part in contact with liquid)	AISI 304
2	Motor bracket	Cast iron GJL200
3	Impeller	Cast iron GJL200
4	Mechanical seal	Carbon/Ceramic/NBR
5	Pump body	Cast iron GJL200

FNS

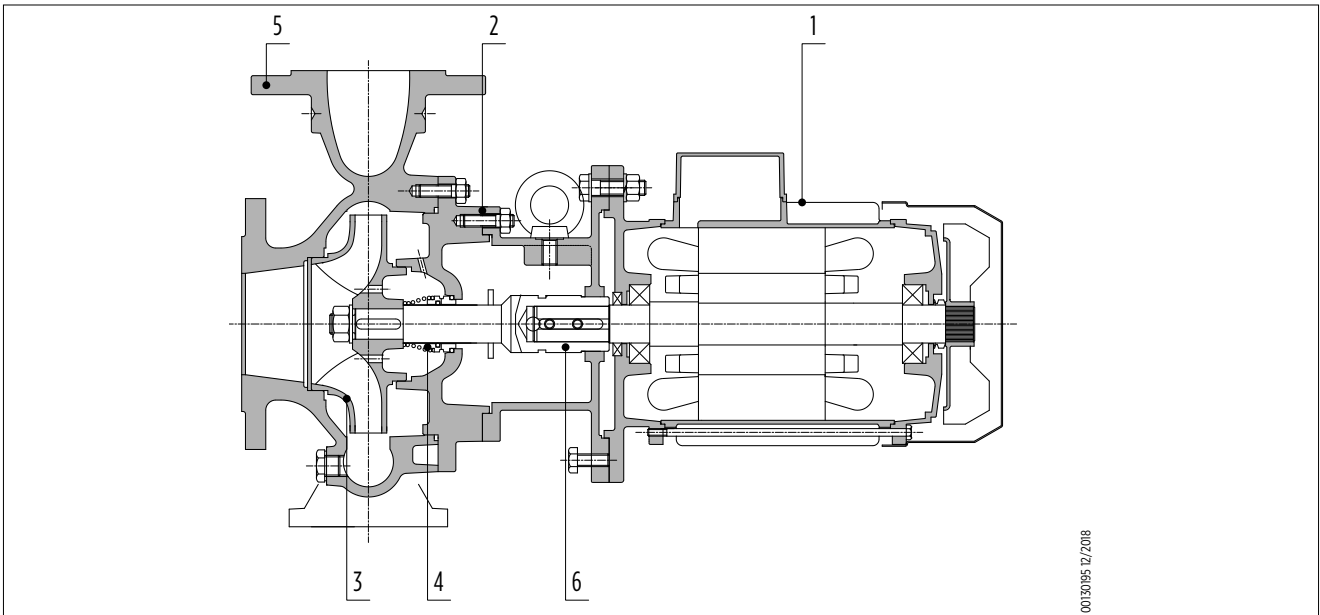

Ref. No	Parts description	Material
1	Motor	See section "Motor specification"
2	Motor bracket	Cast iron GJL200
3	Impeller	Cast iron GJL200
4	Mechanical seal	Carbon/Ceramic/NBR
5	Pump body	Cast iron GJL200
6	Coupling	AISI 303

FNE

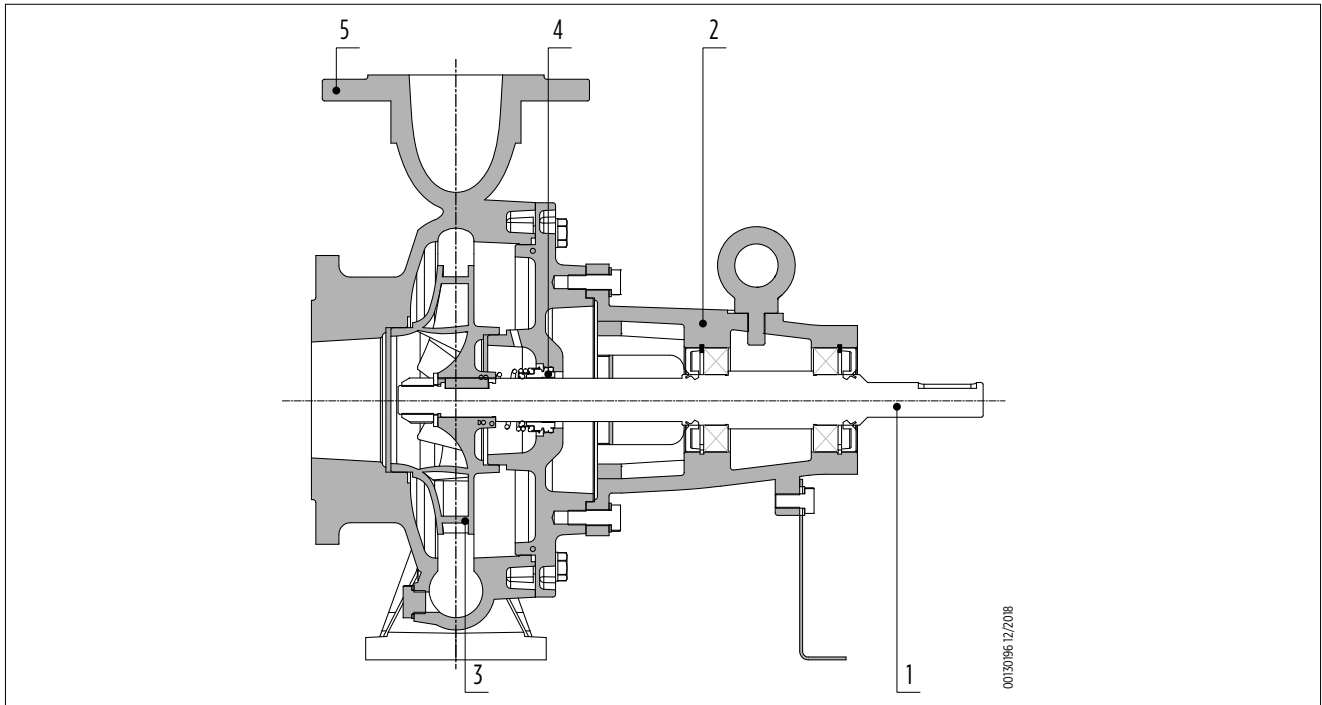

Ref. No	Parts description	Material
1	Pump shaft (part in contact with liquid)	AISI 304
2	Motor bracket	Cast iron GJL200
3	Impeller	Cast iron GJL200
4	Mechanical seal	Carbon/Ceramic/NBR
5	Pump body	Cast iron GJL200

Technical data and dimensions

FNC

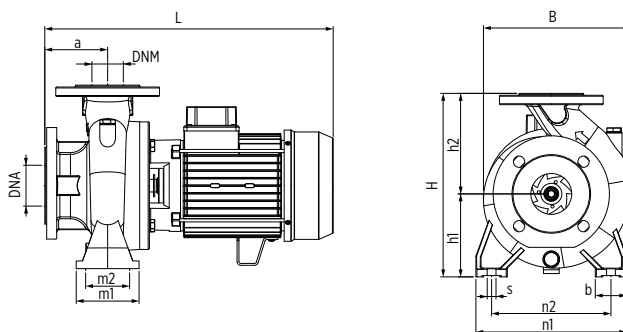

Flanges					
DIMENSIONS [mm]				Holes	
DN	K	D	B	n°	Ø
32	100	140	18	4	18
40	110	150	18	4	18
50	125	165	19	4	18
65	145	185	19	4	18
80	160	200	22	8	18
100	180	220	24	8	18

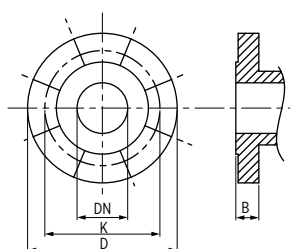

00030193.1/2018

Electric pump model	DIMENSIONS [mm]													
	DNA	DNM	a	b	s	L	B	H	n1	n2	m1	m2	h1	h2
FNC 32-125/011	50	32	80	50	14	400	203	252	190	140	100	70	112	140
FNC 32-125/015	50	32	80	50	14	400	203	252	190	140	100	70	112	140
FNC 32-160/022	50	32	80	50	14	437	240	292	240	190	100	70	132	160
FNC 32-160/030	50	32	80	50	14	400	240	292	240	190	100	70	132	160
FNC 32-200/040	50	32	80	50	14	468	273	340	240	190	100	70	160	180
FNC 32-200/055	50	32	80	50	14	495	273	340	240	190	100	70	160	180
FNC 32-200/075	50	32	80	50	14	537	273	340	240	190	100	70	160	180
FNC 32-250/092	50	32	100	65	14	561	326	405	320	250	125	95	180	225
FNC 32-250/110	50	32	100	65	14	600	326	405	320	250	125	95	180	225
FNC 32-250/150	50	32	100	65	14	682	326	405	320	250	125	95	180	225
FNC 40-125/015	65	40	80	50	14	400	216	252	210	160	100	70	112	140
FNC 40-125/022	65	40	80	50	14	437	216	252	210	160	100	70	112	140
FNC 40-125/030	65	40	80	50	14	463	216	252	210	160	100	70	112	140
FNC 40-160/030	65	40	80	50	14	463	242	292	240	190	100	70	132	160
FNC 40-160/040	65	40	80	50	14	463	242	292	240	190	100	70	132	160
FNC 40-200/055	65	40	100	50	14	515	278	340	265	212	100	70	160	180
FNC 40-200/075	65	40	100	50	14	557	278	340	265	212	100	70	160	180
FNC 40-250/110	65	40	100	65	14	600	328	405	320	250	125	95	180	225
FNC 40-250/150	65	40	100	65	14	682	328	405	320	250	125	95	180	225
FNC 50-125/022	65	50	100	50	14	457	248	292	240	190	100	70	132	160
FNC 50-125/030	65	50	100	50	14	483	248	292	240	190	100	70	132	160
FNC 50-125/040	65	50	100	50	14	483	248	292	240	190	100	70	132	160
FNC 50-160/055	65	50	100	50	14	515	268	340	265	212	100	70	160	180
FNC 50-160/075	65	50	100	50	14	557	268	340	265	212	100	70	160	180
FNC 50-200/092	65	50	100	50	14	561	290	360	265	212	100	70	160	200
FNC 50-200/110	65	50	100	50	14	600	290	360	265	212	100	70	160	200
FNC 50-200/150	65	50	100	50	14	682	290	360	265	212	100	70	160	200
FNC 50-250/150	65	50	100	65	14	682	334	405	320	250	125	95	180	225
FNC 50-250/185	65	50	100	65	14	682	334	405	320	250	125	95	180	225
FNC 50-250/220	65	50	100	65	14	726	334	405	320	250	125	95	180	225
FNC 65-125/055	80	65	100	65	14	515	283	340	280	212	125	95	160	180
FNC 65-125/075	80	65	100	65	14	557	283	340	280	212	125	95	160	180

Electric pump model	DIMENSIONS [mm]													
	DNA	DNM	a	b	s	L	B	H	n1	n2	m1	m2	h1	h2
FNC 65-160/092	80	65	100	65	14	565	290	360	280	212	125	95	160	200
FNC 65-160/110	80	65	100	65	14	605	290	360	280	212	125	95	160	200
FNC 65-160/150	80	65	100	65	14	686	290	360	280	212	125	95	160	200
FNC 65-200/150	80	65	100	65	14	686	330	405	320	250	125	95	180	225
FNC 65-200/185	80	65	100	65	14	686	330	405	320	250	125	95	180	225
FNC 65-200/220	80	65	100	65	14	730	330	405	320	250	125	95	180	225
FNC 80-160/110	100	80	125	65	14	628	330	405	320	250	125	95	180	225
FNC 80-160/150	100	80	125	65	14	710	330	405	320	250	125	95	180	225
FNC 80-160/185	100	80	125	65	14	710	330	405	320	250	125	95	180	225
FNC 80-160/220	100	80	125	65	14	755	330	405	320	250	125	95	180	225

FNS

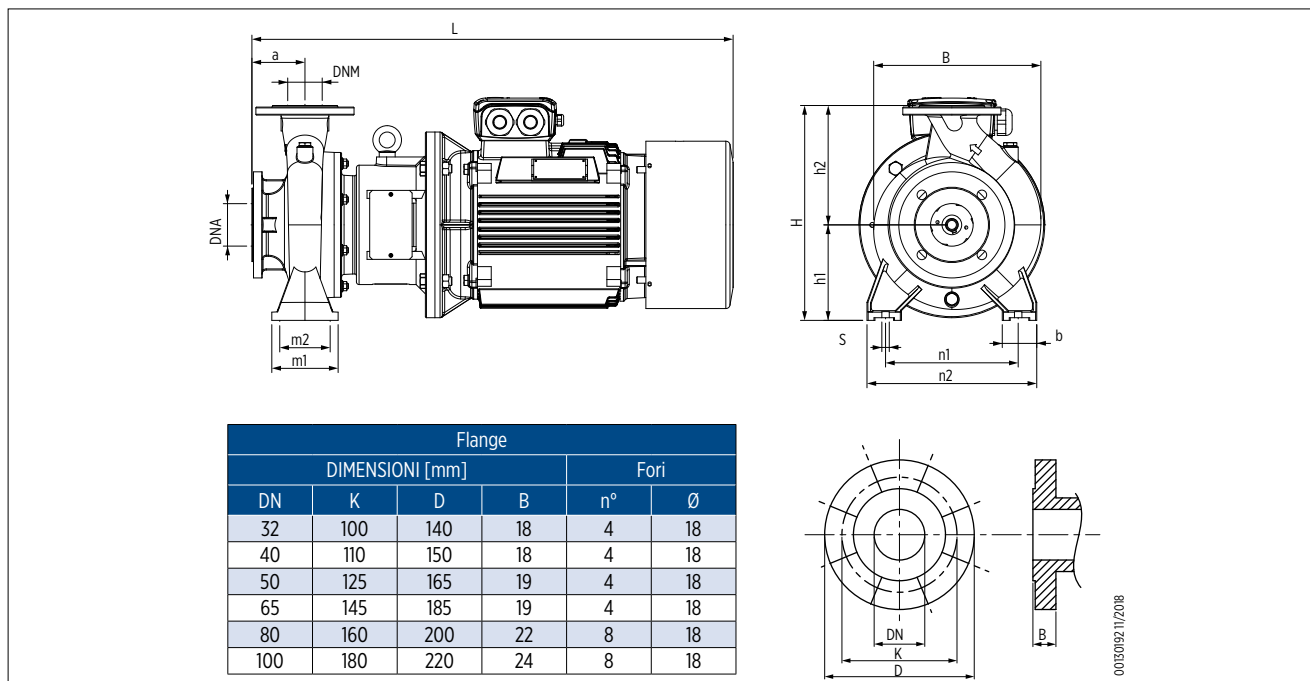

Electric pump model	IEC size	DIMENSIONS [mm]													
		DNA	DNM	a	b	s	L	B	H	n1	n2	m1	m2	h1	h2
FNS 32-200/055	132	50	32	80	50	14	638	273	340	240	190	100	70	160	180
FNS 32-200/075	132	50	32	80	50	14	658	273	340	240	190	100	70	160	180
FNS 32-250/092	132	50	32	100	65	14	751	326	405	320	250	125	95	180	225
FNS 32-250/110	160	50	32	100	65	14	824	326	405	320	250	125	95	180	225
FNS 32-250/150	160	50	32	100	65	14	824	326	405	320	250	125	95	180	225
FNS 40-200/055	132	65	40	100	50	14	643	278	340	265	212	100	70	160	180
FNS 40-200/075	132	65	40	100	50	14	663	278	340	265	212	100	70	160	180
FNS 40-250/110	160	65	40	100	65	14	826	328	405	320	250	125	95	180	225
FNS 40-250/150	160	65	40	100	65	14	826	328	405	320	250	125	95	180	225
FNS 50-160/055	132	65	50	100	50	14	633	268	340	265	212	100	70	160	180
FNS 50-160/075	132	65	50	100	50	14	653	268	340	265	212	100	70	160	180
FNS 50-200/092	132	65	50	100	50	14	715	290	360	265	212	100	70	160	200
FNS 50-200/110	160	65	50	100	50	14	788	290	360	265	212	100	70	160	200
FNS 50-200/150	160	65	50	100	50	14	788	290	360	265	212	100	70	160	200
FNS 50-250/150	160	65	50	100	65	14	832	334	405	320	250	125	95	180	225
FNS 50-250/185	160	65	50	100	65	14	876	334	405	320	250	125	95	180	225
FNS 50-250/220	180	65	50	100	65	14	876	334	405	320	250	125	95	180	225
FNS 65-125/055	132	80	65	100	65	14	648	283	340	280	212	125	95	160	180
FNS 65-125/075	132	80	65	100	65	14	668	283	340	280	212	125	95	160	180
FNS 65-160/092	132	80	65	100	65	14	715	290	360	280	212	125	95	160	200
FNS 65-160/110	160	80	65	100	65	14	788	290	360	280	212	125	95	160	200
FNS 65-160/150	160	80	65	100	65	14	788	290	360	280	212	125	95	160	200
FNS 65-200/150	160	80	65	100	65	14	828	330	405	320	250	125	95	180	225
FNS 65-200/185	160	80	65	100	65	14	872	330	405	320	250	125	95	180	225
FNS 65-200/220	180	80	65	100	65	14	872	330	405	320	250	125	95	180	225
FNS 65-250/300	200	80	65	100	80	18	1033	375	450	360	280	160	120	200	250
FNS 65-250/370	200	80	65	100	80	18	1033	375	450	360	280	160	120	200	250
FNS 80-160/110	160	100	80	125	65	14	828	330	405	320	250	125	95	180	225
FNS 80-160/150	160	100	80	125	65	14	828	330	405	320	250	125	95	180	225
FNS 80-160/185	160	100	80	125	65	14	872	330	405	320	250	125	95	180	225
FNS 80-160/220	180	100	80	125	65	14	872	330	405	320	250	125	95	180	225
FNS 80-200/300	200	100	80	125	65	18	1028	370	430	345	280	125	95	180	250
FNS 80-200/370	200	100	80	125	65	18	1028	370	430	345	280	125	95	180	250

Electric pump model	IEC size	DIMENSIONS [mm]													
		DNA	DNM	a	b	s	L	B	H	n1	n2	m1	m2	h1	h2
FNS 80-250/450	225	100	80	125	80	18	1119	420	480	400	315	160	120	200	280
FNS 80-250/550	250	100	80	125	80	18	1198	420	480	400	315	160	120	200	280
FNS 80-250/750	280	100	80	125	80	18	1264	420	480	400	315	160	120	200	280

FNE

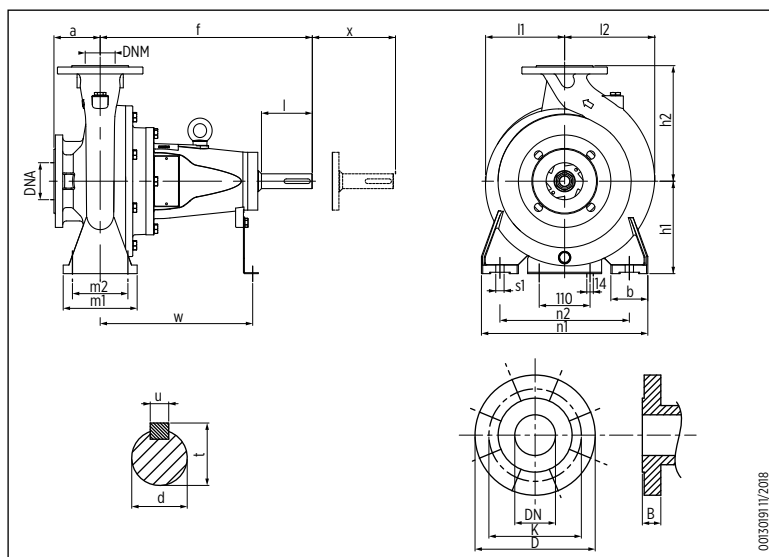

Flanges					
DIMENSIONS [mm]				Holes	
DN	K	D	B	n°	Ø
32	100	140	18	4	18
40	110	150	18	4	18
50	125	165	19	4	18
65	145	185	19	4	18
80	160	200	22	8	18
100	180	220	24	8	18

SHAFT DIMENSIONS [mm]			
d	l	u	t
24 j6	50	8	27
32 k6	80	10	35
42 k6	110	12	45

Pump model	IEC size	DIMENSIONS [mm]																
		DNA	DNM	a	f	h1	h2	l1	l2	m1	m2	n1	n2	b	s1	d	w	x
FNE 32-125/011	80																	
FNE 32-125/015	90	50	32	80	356	112	140	102	102	100	70	190	140	50	14	24	254	100
FNE 32-160/022	90																	
FNE 32-160/030	100	50	32	80	360	132	160	116,5	116,5	100	70	240	190	50	14	24	254	100
FNE 32-200/040	112																	
FNE 32-200/055	132	50	32	80	356	160	180	140	140	100	70	240	190	50	14	24	254	100
FNE 32-200/075	132																	
FNE 32-250/092	132																	
FNE 32-250/110	160	50	32	100	360	180	225	166	166	125	95	320	250	65	14	24	254	100
FNE 32-250/150	160																	
FNE 40-125/015	90																	
FNE 40-125/022	90	65	40	80	356	112	160	116,5	116,5	100	70	240	190	50	14	24	254	100
FNE 40-125/030	100																	
FNE 40-160/030	100																	
FNE 40-160/040	112	65	40	80	360	132	160	116,5	121,5	100	70	240	190	50	14	24	254	100
FNE 40-200/055	132																	
FNE 40-200/075	132	65	40	100	356	160	180	140	140	100	70	265	212	50	14	24	254	100
FNE 40-250/110	160																	
FNE 40-250/150	160	65	40	100	360	180	225	166	166	125	95	320	250	65	14	24	254	100
FNE 50-125/022	90																	
FNE 50-125/030	100	65	50	80	356	132	160	101,5	112	100	70	210	190	50	14	24	254	100
FNE 50-125/040	112																	
FNE 50-160/055	132	65	50	100	356	160	180	120	136	100	70	265	212	50	14	24	254	100
FNE 50-160/075	132																	
FNE 50-200/092	132																	
FNE 50-200/110	160	65	50	100	360	160	200	140	150	100	70	265	212	50	14	24	254	100
FNE 50-200/150	160																	
FNE 50-250/150	160																	
FNE 50-250/185	160	65	50	100	360	180	225	166	170	125	95	320	250	65	14	24	254	100
FNE 50-250/220	160																	
FNE 65-125/055	132																	
FNE 65-125/075	132	80	65	100	356	160	180	112	143	125	95	280	212	65	14	24	254	100
FNE 65-160/092	132																	
FNE 65-160/110	160	80	65	100	365	160	200	123	148	125	95	280	212	65	14	24	258	100
FNE 65-160/150	160																	

Pump model	IEC size	DIMENSIONS [mm]																
		DNA	DNM	a	f	h1	h2	l1	l2	m1	m2	n1	n2	b	s1	d	w	x
FNE 65-200/150	160	80	65	100	365	180	225	147	168	125	95	320	250	65	14	24	258	140
FNE 65-200/185	160																	
FNE 65-200/220	160																	
FNE 65-250/300	200	80	65	100	460	200	250	170	195	160	120	360	280	80	18	32	330	140
FNE 65-250/370	200																	
FNE 80-160/110	160	100	80	125	365	180	225	135	170	125	95	320	250	65	14	24	258	140
FNE 80-160/150	160																	
FNE 80-160/185	160																	
FNE 80-160/220	160																	
FNE 80-200/300	200	100	80	125	470	180	250	165	195	125	95	350	280	65	18	32	340	140
FNE 80-200/370	200																	
FNE 80-250/450	225	100	80	125	470	200	280	195	218	160	120	400	315	80	18	32	340	140
FNE 80-250/550	250																	
FNE 80-250/750	280																	



Hydraulic performance at 50 Hz

FNE - HYDRAULIC PERFORMANCE AT 50 HZ

Pump model	RATED POWER		Q = DELIVERY																					
			m ³ /h 0	3	6	9	12	15	18	21	24	27	30	33	36	39	42	45	48	57	60	66	72	
			l/min 0	50	100	150	200	250	300	350	400	450	500	550	600	650	700	750	800	950	1000	1100	1200	
Only hydraulic	[kW]	[HP]	H = TOTAL M.HEAD OF WATER COLUMN [m]																					
FNE 32-125/011	1.1	1.5	21.5	21	20	19	17	14																
FNE 32-125/015	1.5	2	26.5	26.5	26	25	23.5	21	18.5															
FNE 32-160/022	2.2	3	30	30	29.5	29	28	27	25	22	18.5													
FNE 32-160/030	3	4	37	37	36.5	36	35.5	34.5	33	31	28.5													
FNE 32-200/040	4	5.5	43.5	43	43	42	41.5	40	38.5	37	34.5	31.5												
FNE 32-200/055	5.5	7.5	51.5	51.5	51	50.5	49.5	48.5	47.5	45.5	43.5	41												
FNE 32-200/075	7.5	10	60.5	60.5	60.5	60	59.5	58.5	57.5	56	54.5	52												
FNE 32-250/092	9.2	12.5	74	74	74	74	73	72	70.5	68.5	66	63	59											
FNE 32-250/110	11	15	87	87	87	87	87	87	86	85	83	80.5	77											
FNE 32-250/150	15	20	97	97.5	97.5	97.5	97	97	96.5	96	94	91.5	86.5	78.5										
FNE 40-125/015	1.5	2	18.5	18.5	19	19	18.5	18.5	18	17.5	16.5	16	15											
FNE 40-125/022	2.2	3	22	22	22.5	22.5	22	22	21.5	21	20	19.5	17	16										
FNE 40-125/030	3	4	26	27	27	27.5	27.5	27.5	27	27	26.5	26	25	24	23									
FNE 40-160/030	3	4	32	32	32	31.5	31	30.5	30	29	28	27	25.5	24	22									
FNE 40-160/040	4	5.5	37.5	38	38	37.5	37	37	36	35	34	33	31.5	30	28.5	26.5								
FNE 40-200/055	5.5	7.5	44	44.5	44.5	44.5	44.5	44	43.5	43	42	41	39.5	37.5	35.5									
FNE 40-200/075	7.5	10	53	53.5	53.5	53.5	53.5	53.5	53	52.5	52	51	49.5	48	46	43.5								
FNE 40-250/110	11	15	72.5	72.5	72.5	72	71.5	71	70	69	68	66.5	65	63.5	61.5	59	57							
FNE 40-250/150	15	20	85	85	85.5	86	86	86	85.5	85	84.5	84	82.5	81.5	80	78	76	73.5	70.5					
FNE 50-125/022	2.2	3	17	17	17.5	17.5	18	18	17.5	17.5	17.5	17	17	16.5	16	15.5	15	14						
FNE 50-125/030	3	4	22.5	22.5	23	23	23	22.5	22.5	22.5	22	22	21.5	21	20.5	20	19.5	18.5	18	15				
FNE 50-125/040	4	5.5	24	24.5	24.5	24.5	24.5	24.5	24.5	24.5	24	24	23.5	23.5	23	22.5	22	21	20.5	17.5				
FNE 50-160/055	5.5	7.5	30	30.5	31	31	31.5	31.5	31.5	31	31	30.5	30	30	29.5	29	28	27.5	26.5	24	23	21	18.5	
FNE 50-160/075	7.5	10	38	38.5	38.5	39	39	39	39	39	39	39	39	39	38.5	38.5	38	37.5	37	36	34	33	31	28
FNE 50-200/092	9.2	12.5	45.5	46	46.5	47	47	47	47	47	47	46.5	46	45.5	44.5	43.5	42.5	41	40	35	33	28	23	
FNE 50-200/110	11	15	53	53.5	54	54.5	54.5	54.5	54.5	54	53.5	53	52.5	51.5	50.5	49.5	48	46.5	41.5	39.5	35.5	30.5	30.5	
FNE 50-200/150	15	20	60	60.5	61	61.5	61.5	61.5	61.5	61	60.5	60	59.5	58.5	57.5	56	55	53.5	48.5	46.5	42	37.5	37.5	
FNE 50-250/150	15	20	73	74	74	74.5	75	75	75	75	75	74.5	74.5	74	73.5	72.5	72	71	70	66.5	65			
FNE 50-250/185	18.5	25	82	82.5	82.5	82.5	82.5	82.5	82.5	82.5	82.5	82	82	81.5	81	80.5	80	79	78	74.5	73	70	66	
FNE 50-250/220	22	30	87.5	88	88	88	88.5	88.5	89	89	89	88.5	88.5	88	88	87.5	87	86	85.5	82	81	78	74	

Pump model	RATED POWER		Q = DELIVERY																							
			m ³ /h 0	12	24	30	36	42	48	54	60	66	72	78	84	96	102	120	132	144	156	168	180	192	240	
			l/min 0	200	400	500	600	700	800	900	1000	1100	1200	1300	1400	1600	1700	2000	2200	2400	2600	2800	3000	3200	4000	
Only hydraulic	[kW]	[HP]	H = TOTAL M.HEAD OF WATER COLUMN [m]																							
FNE 65-125/055	5.5	7.5	24	24	24	24	24	23.5	23	23	22.5	22	21	20.5	19.5											
FNE 65-125/075	7.5	10	25	25	25	25	25	25	25	25	24.5	24	23.5	22.5	22	20	18.5									
FNE 65-160/092	9.2	12.5	32	32.5	33	33	33	33	33	33	32.5	32	31.5	31	30	28	27	22								
FNE 65-160/110	11	15	37	38	39	39	39	39	39	39	38.5	38	37.5	36.5	36	34	32.5	28								
FNE 65-160/150	15	20	42	44	44.5	45	45	45	45	45	44.5	44	44	43	42	40	39	35								
FNE 65-200/150	15	20	42.5	46	47	47.5	48	48	48	48	47.5	47	47	46.5	45	44	41									
FNE 65-200/185	18.5	25	47	48.5	50	50	50.5	50.5	50.5	50.5	50	50	49.5	49	47.5	46.5	43.5	41								
FNE 65-200/220	22	30	50.5	52	53.5	54	54	54.5	54.5	54.5	54	54	53.5	53	52.5	51	50	47	44							
FNE 65-250/300	30	40	71	72	72.5	73	73	73	73	73	73	72.5	72	72	71	70	69	66	63	59.5						
FNE 65-250/370	37	50	80	81	82	82	82.5	82.5	82.5	82.5	82.5	82	81.5	81	80	79	76	73	70	66						
FNE 80-160/110	11	15	27.5	27.5	28	28	28	28	28	28	28	28	28	27.5	27.5	27	26.5	25.5	24.5	23	21.5					
FNE 80-160/150	15	20	32	32	32.5	33	33	33	33	33	33	33	33	33	33	32.5	32	31	29.5	28	26.5					
FNE 80-160/185	18.5	25	33	33.5	34	34	34	34.5	34.5	34.5	34.5	34.5	34.5	34.5	34	34	33.5	32	31	29.5	28	25.5	23			
FNE 80-160/220	22	30	37	38	38	38.5	38.5	38.5	39	39	39	39	39	39	38.5	38.5	38	38	36.5	35.5	34	32.5	30.5	28		
FNE 80-200/300	30	40	51	53	54	54.5	54.5	55.4	56	56	56.5	56.5	56.6	56.6	56.5	56.5	56	55	54	52.5	50.5	48.5	46.5			
FNE 80-200/370	37	50	61	62.5	63.5	64	64.5	65	65.5	66	66	66	66.5	66.5	66.5	66.5	66.5	65.5	65	64	62.5	51	59.5			
FNE 80-250/450	45	60	68	68.5	69	69.5	69.5	70	70	70	70.5	70.5	70.5	70.5	70	70	69.5	68.5	67.5	66.5	65	63	61	50		
FNE 80-250/550	55	75	87	87.5	88	88	88.5	88.5	89	89	89	89	89.5	89.5	89.5	88	88	87	86	85	84	82.5	81	79	70.5	
FNE 80-250/750	75	100	101	102	102.5	103	103	103	103.5	103.5	104	104	104	104	104	104	104	104	103.5	103	102	101	100	92		

FNC/FNE 32-125 - PERFORMANCE CURVES

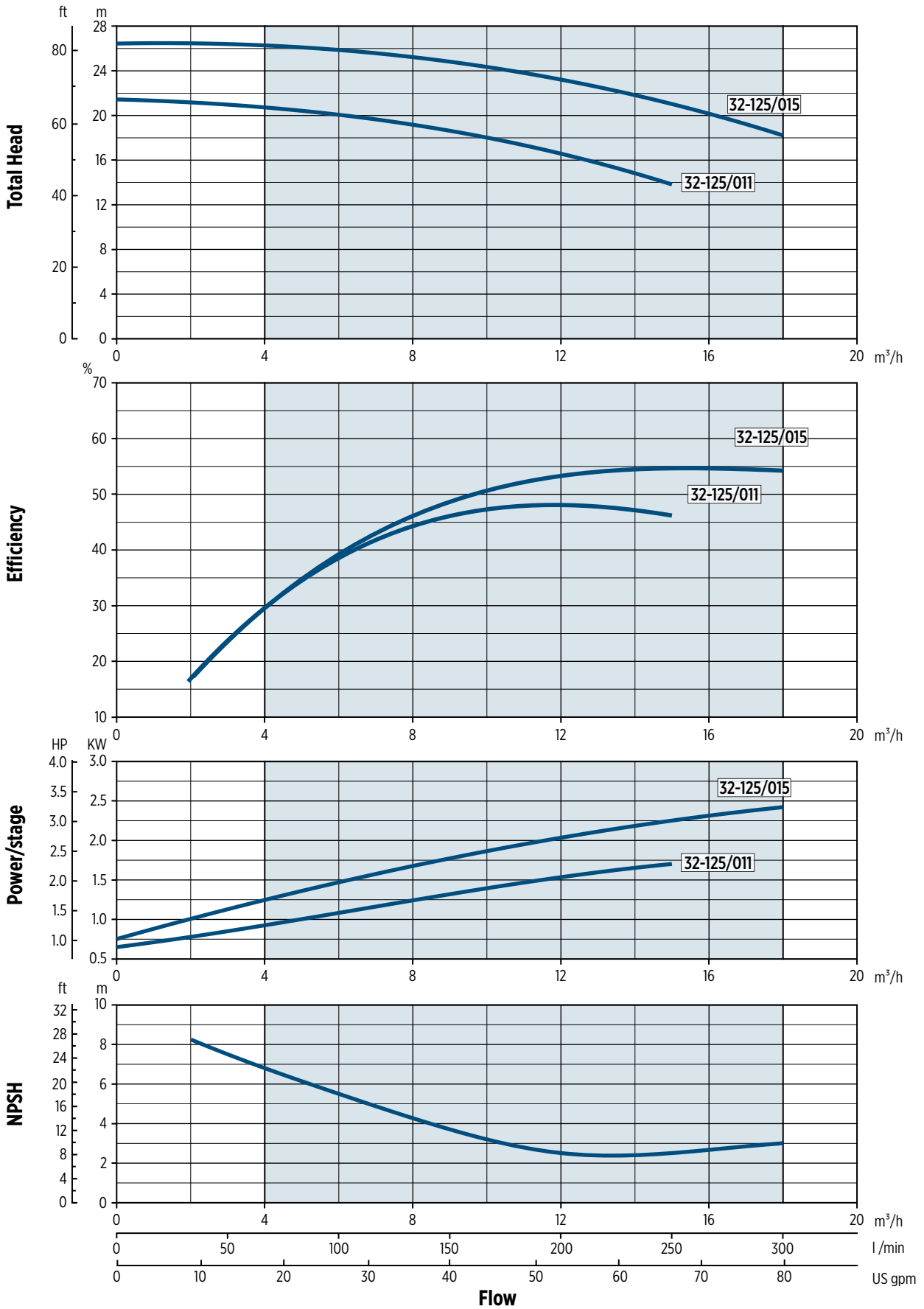

002028EN 02/2019

FNC/FNE 32-160 - PERFORMANCE CURVES

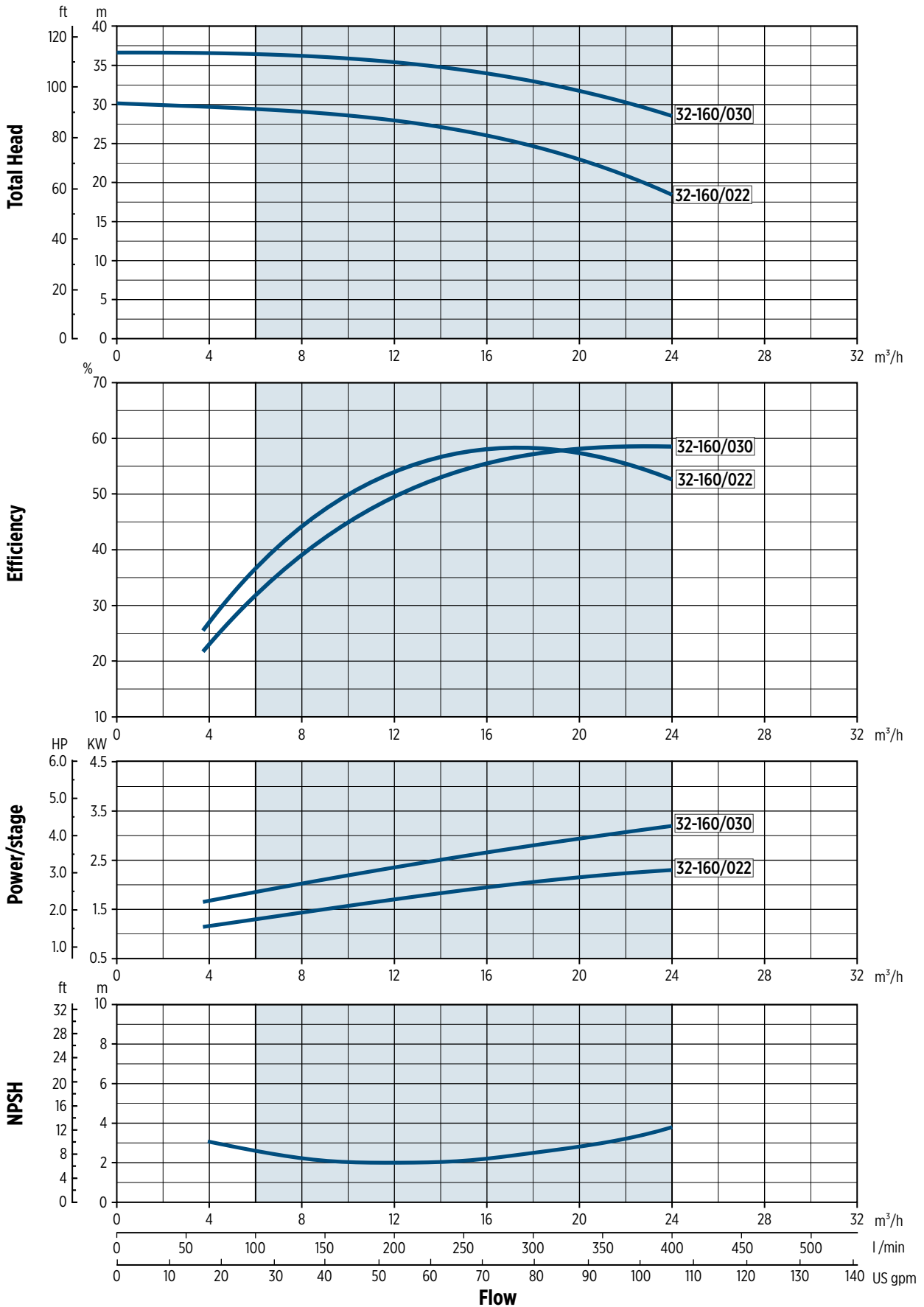

002085EN 02/2019

FNC/FNS/FNE 32-200 - PERFORMANCE CURVES

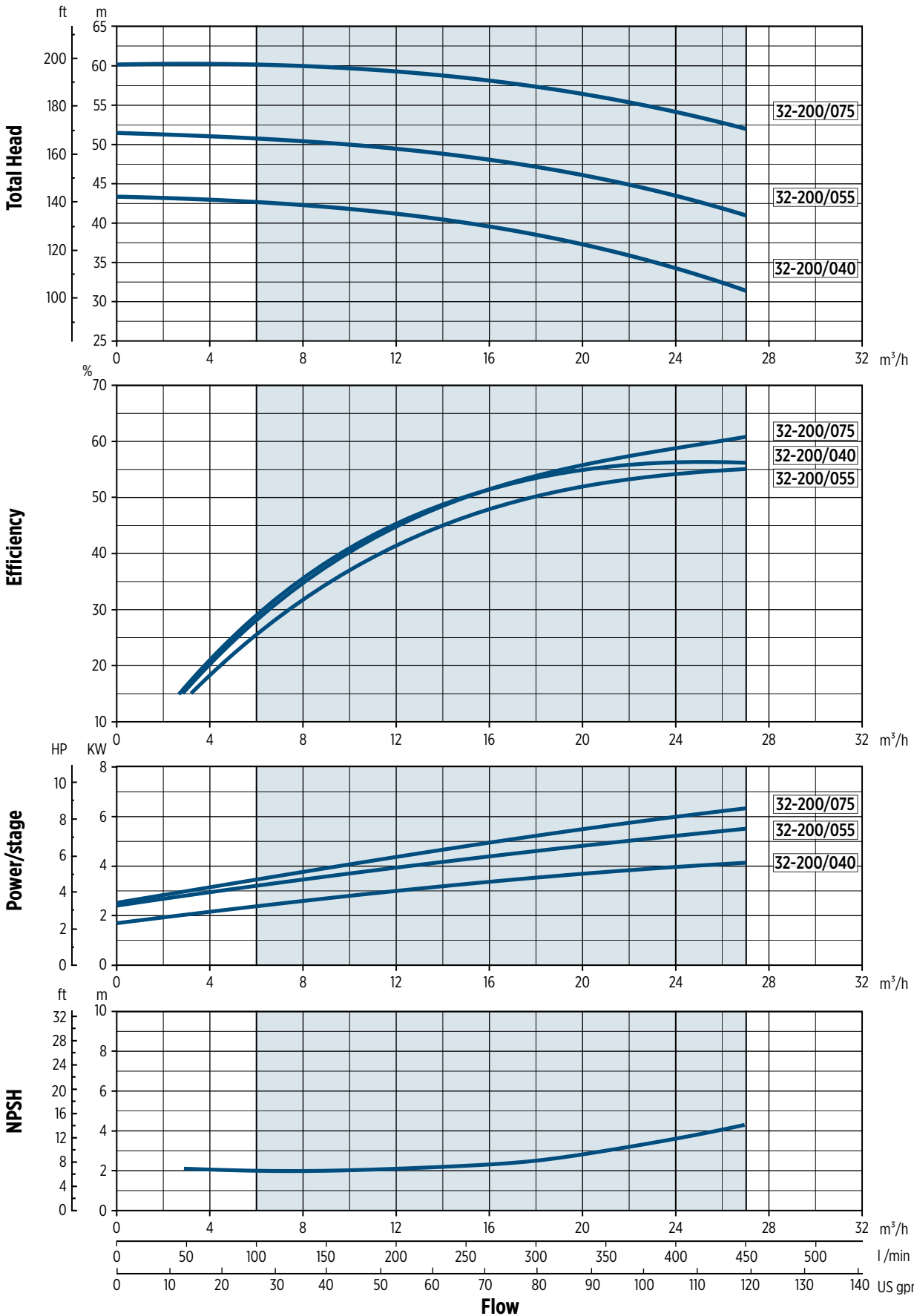

00120204EN/02/2019

FNC/FNS/FNE 32-250 - PERFORMANCE CURVES

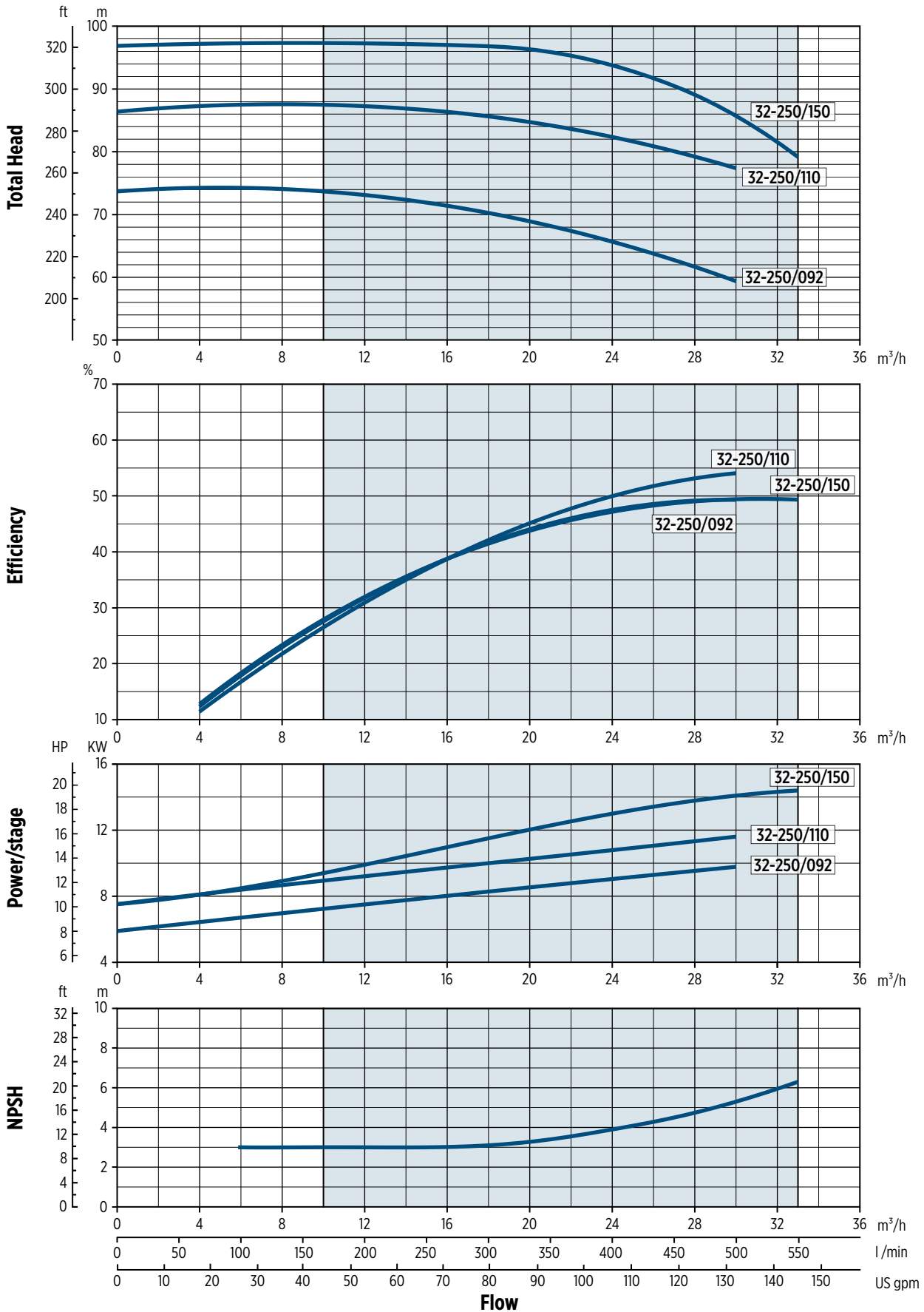

00120205EN 02/2019

FNC/FNE 40-125 - PERFORMANCE CURVES

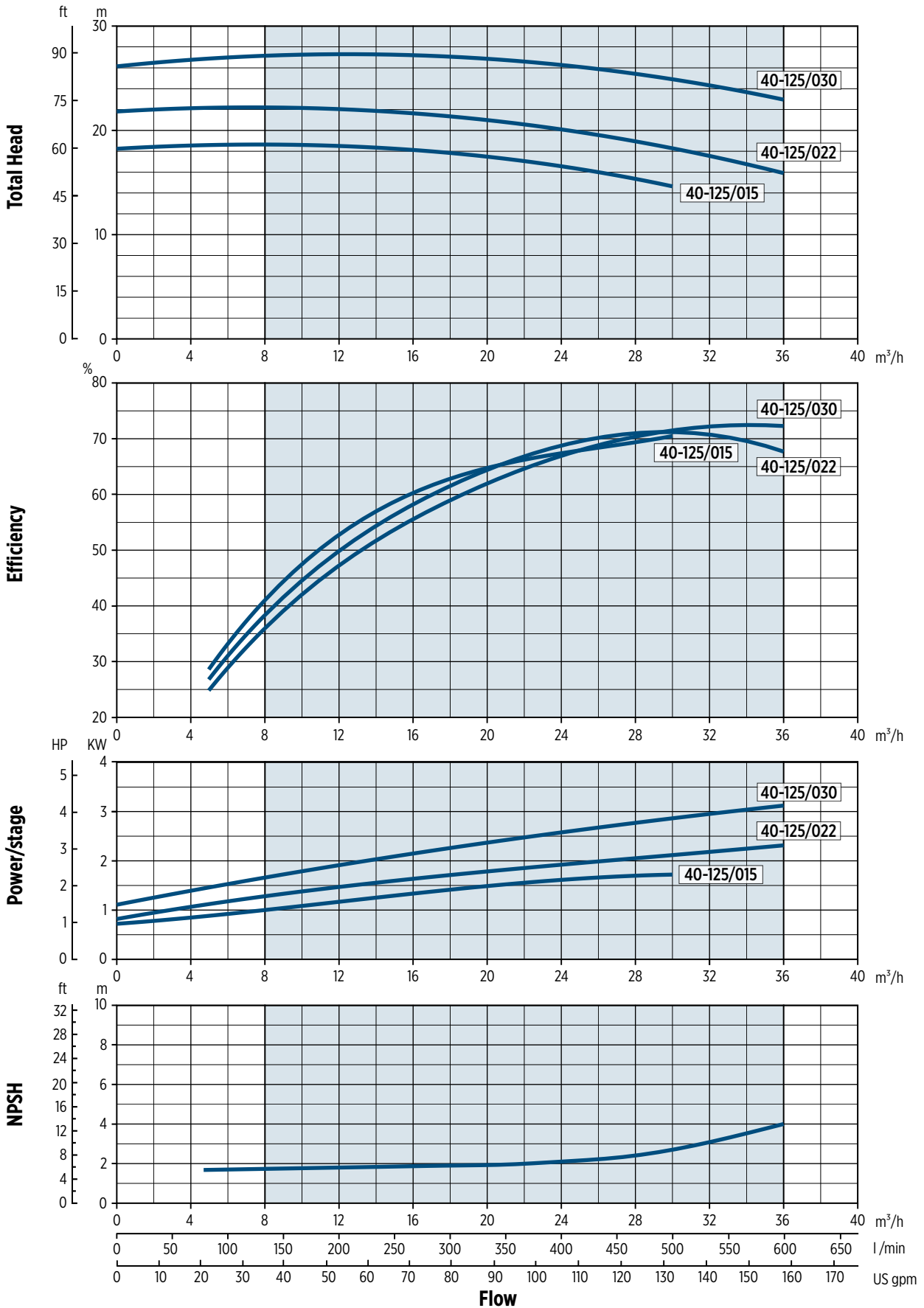

0010206EN 02/2019

FNC/FNE 40-160 - PERFORMANCE CURVES

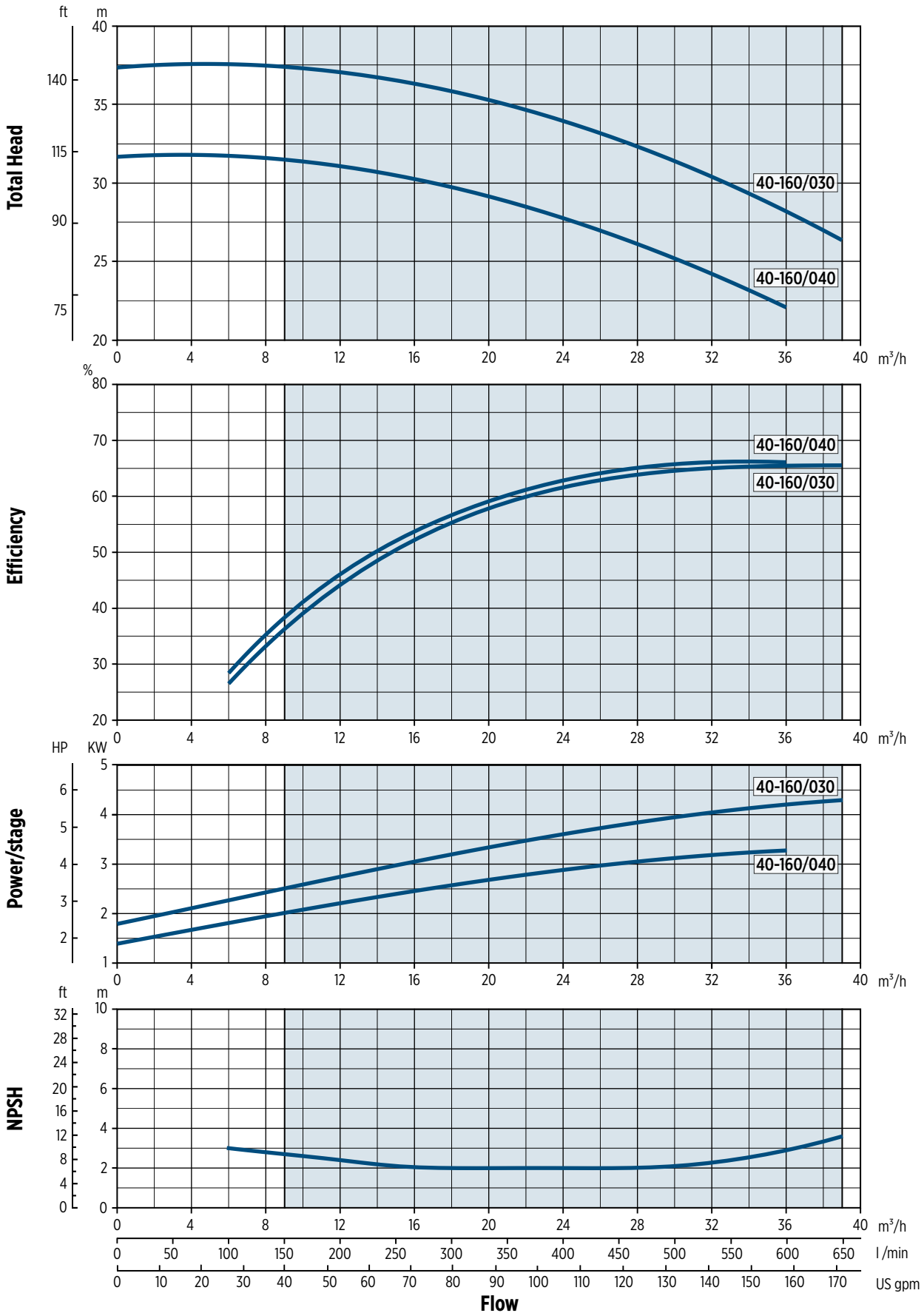

002020TEN 02/2019

FNC/FNS/FNE 40-200 - PERFORMANCE CURVES

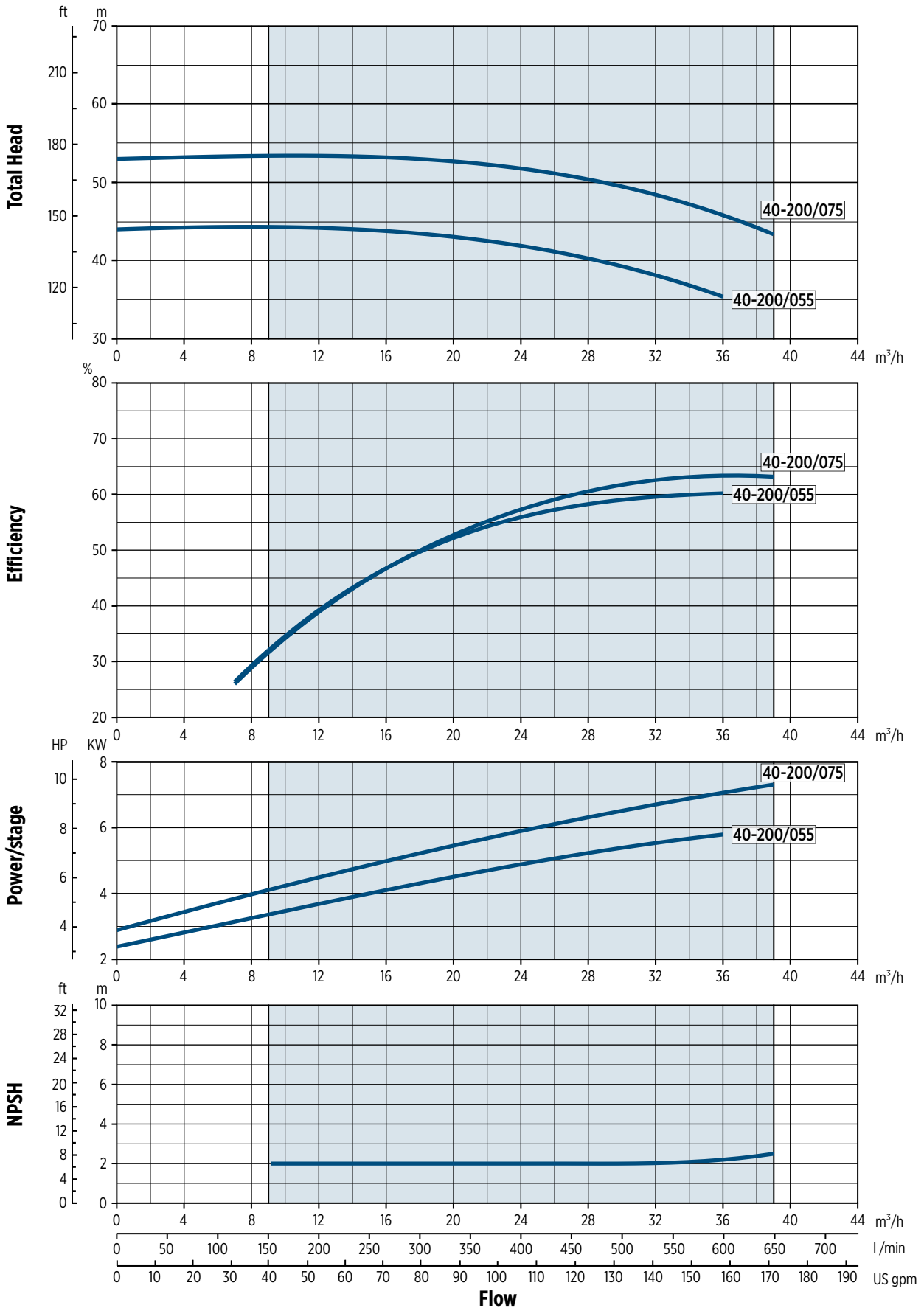

0020208EN 03/2019



FNC/FNS/FNE 40-250 - PERFORMANCE CURVES

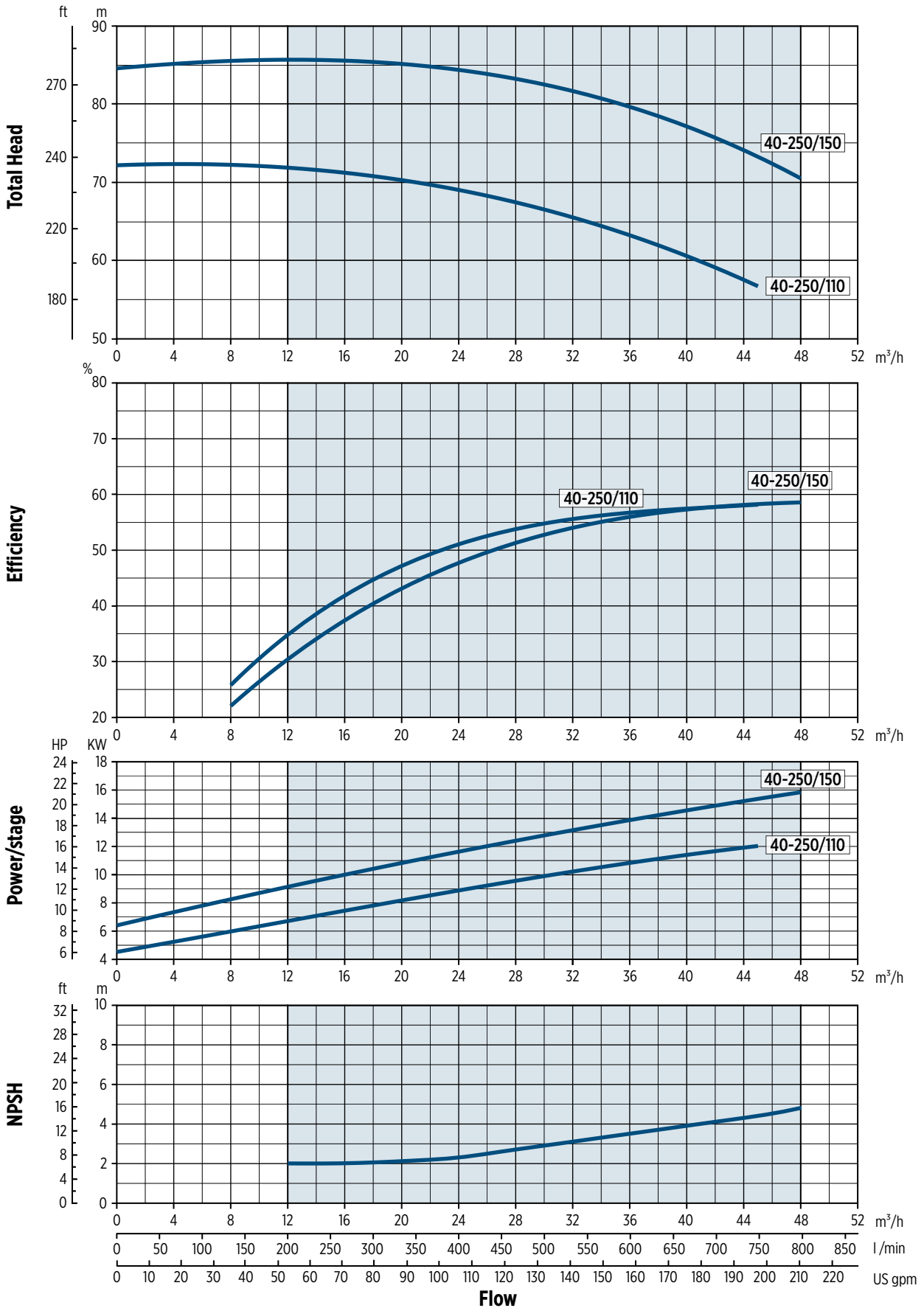

0020209EN 03/2019

FNC/FNE 50-125 - PERFORMANCE CURVES

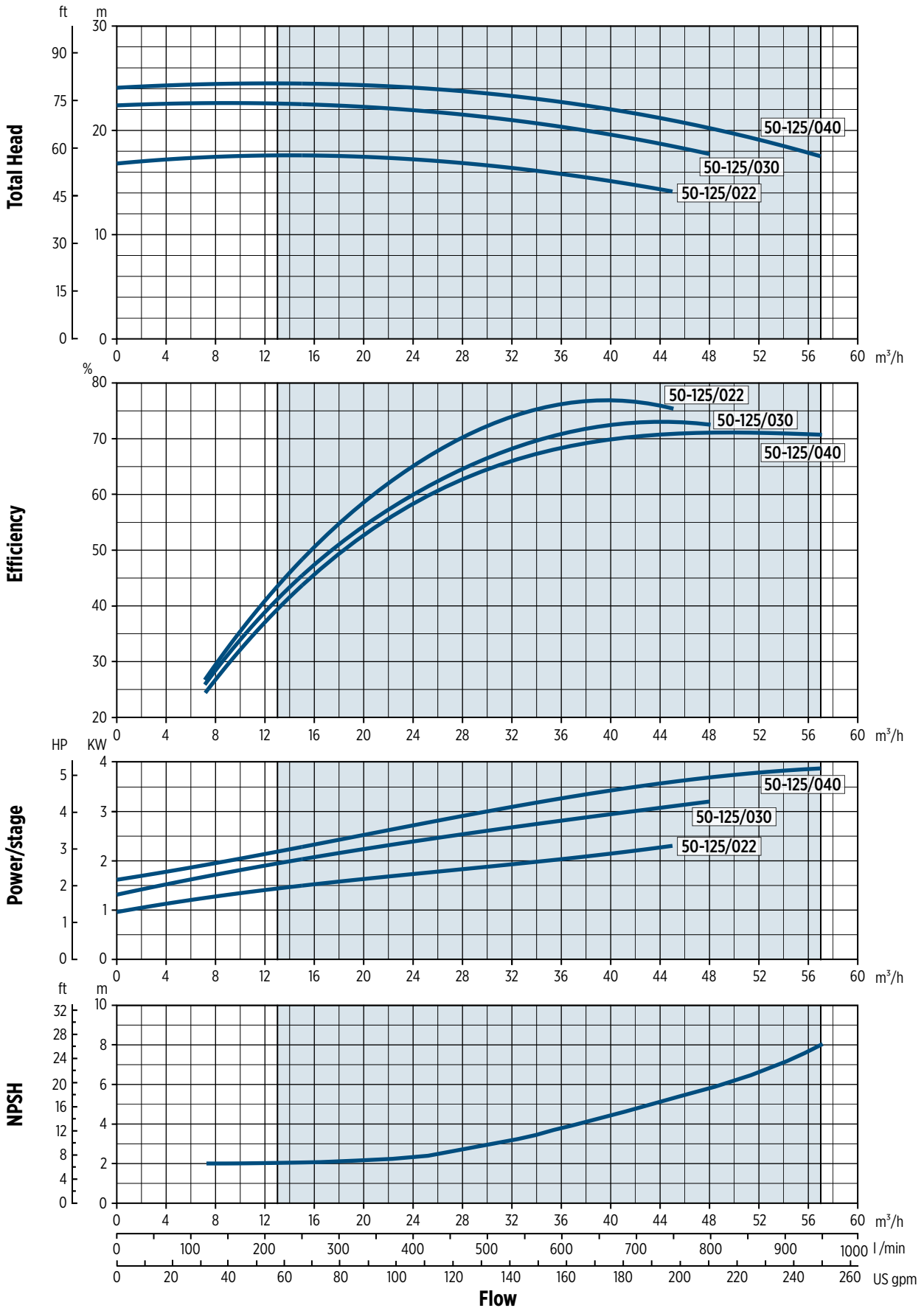

0012020EN 03/2019



FNC/FNS/FNE 50-160 - PERFORMANCE CURVES

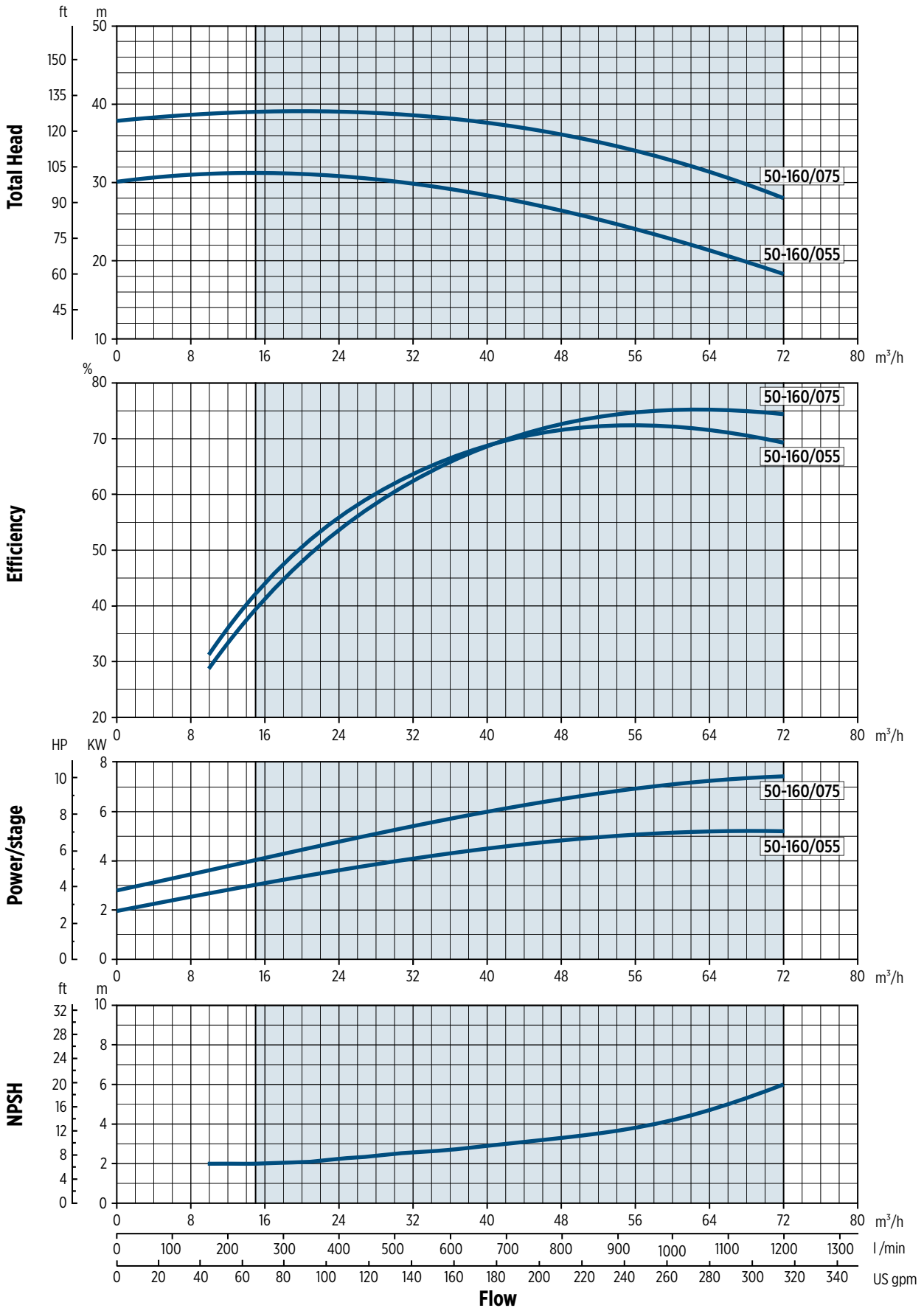

002021EN 03/2019

FNC/FNS/FNE 50-200 - PERFORMANCE CURVES

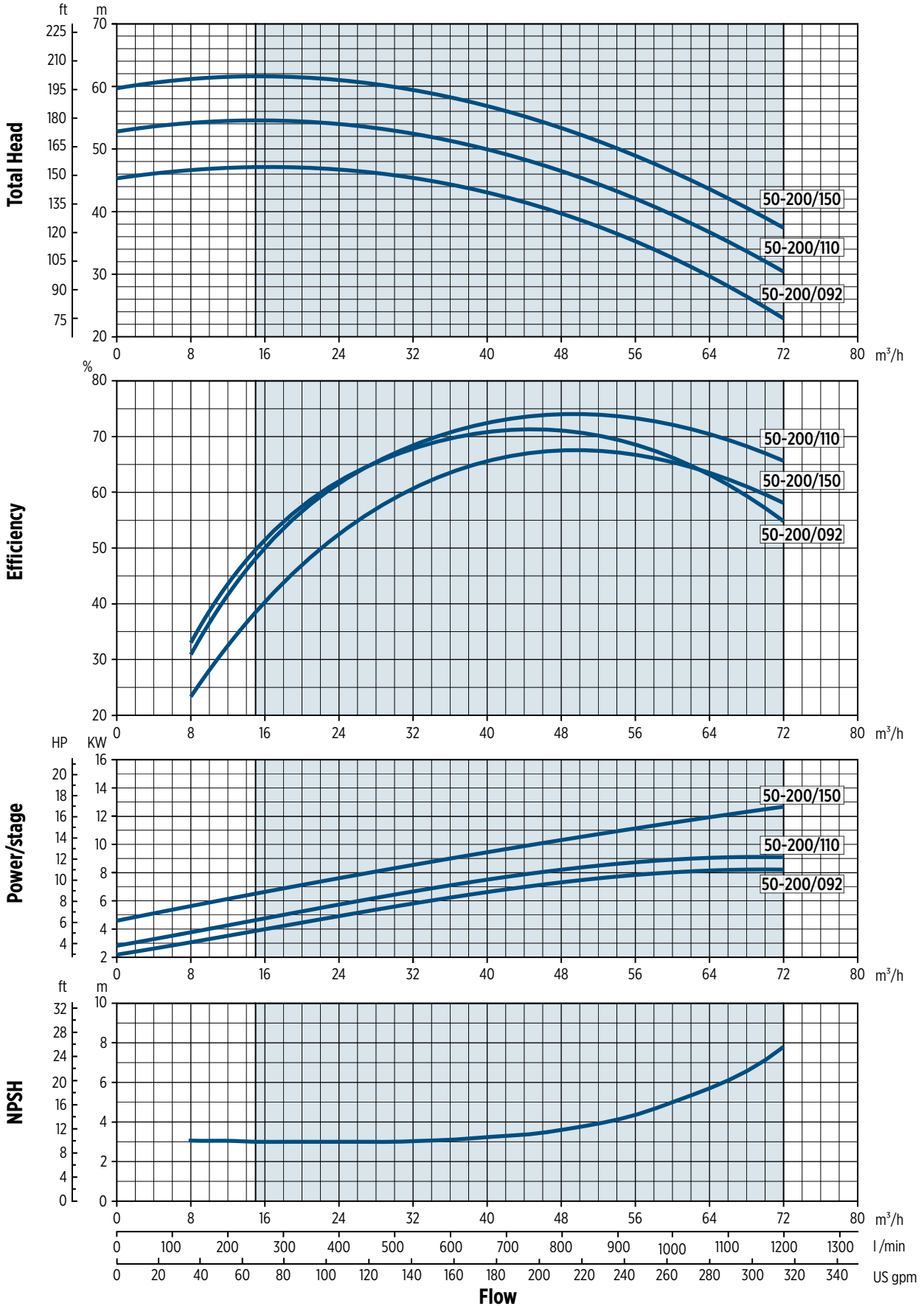

002022EN 05/2019



FNC/FNS/FNE 50-250 - PERFORMANCE CURVES

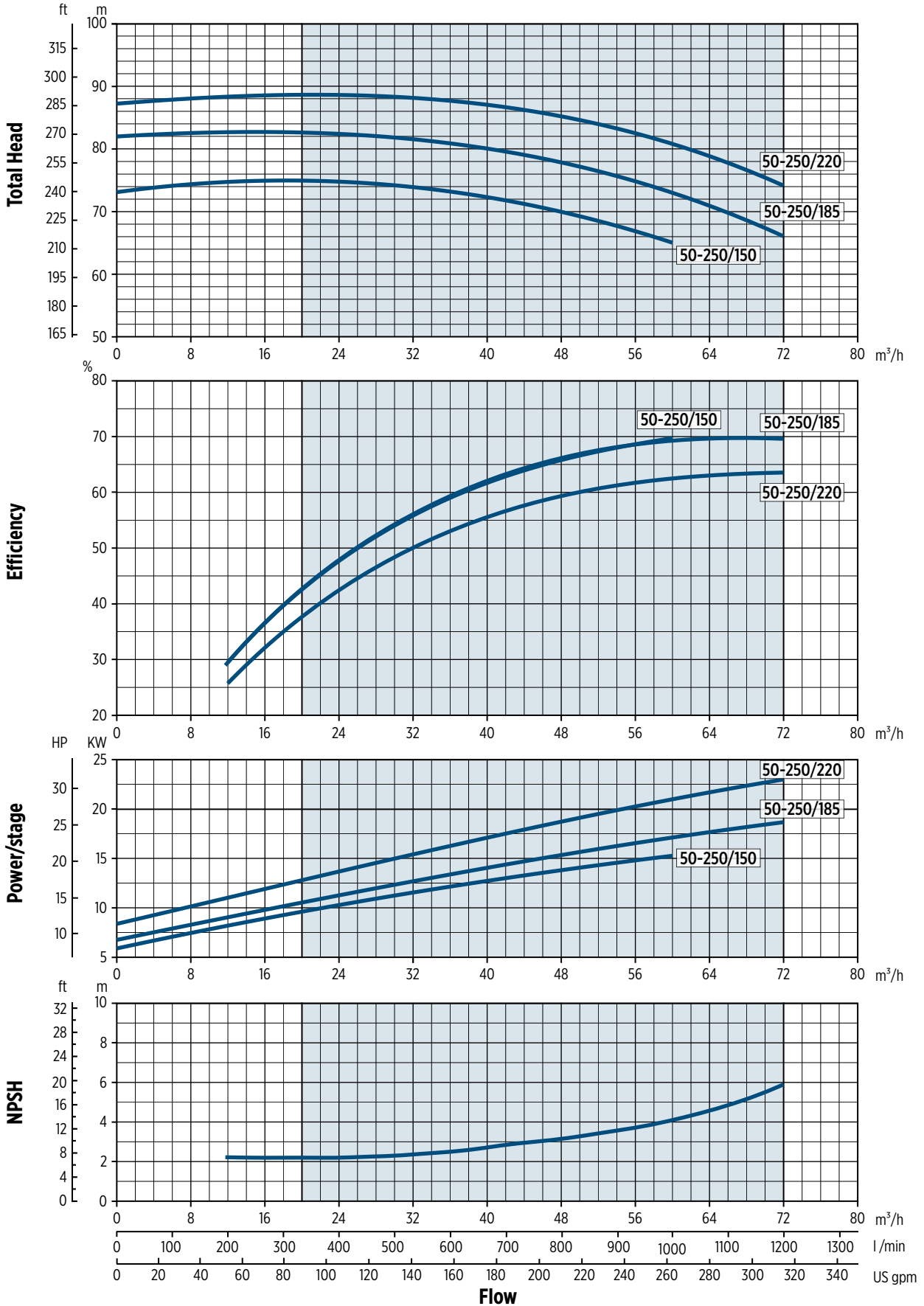

001025EN 05/2019

FNC/FNS/FNE 65-125 - PERFORMANCE CURVES

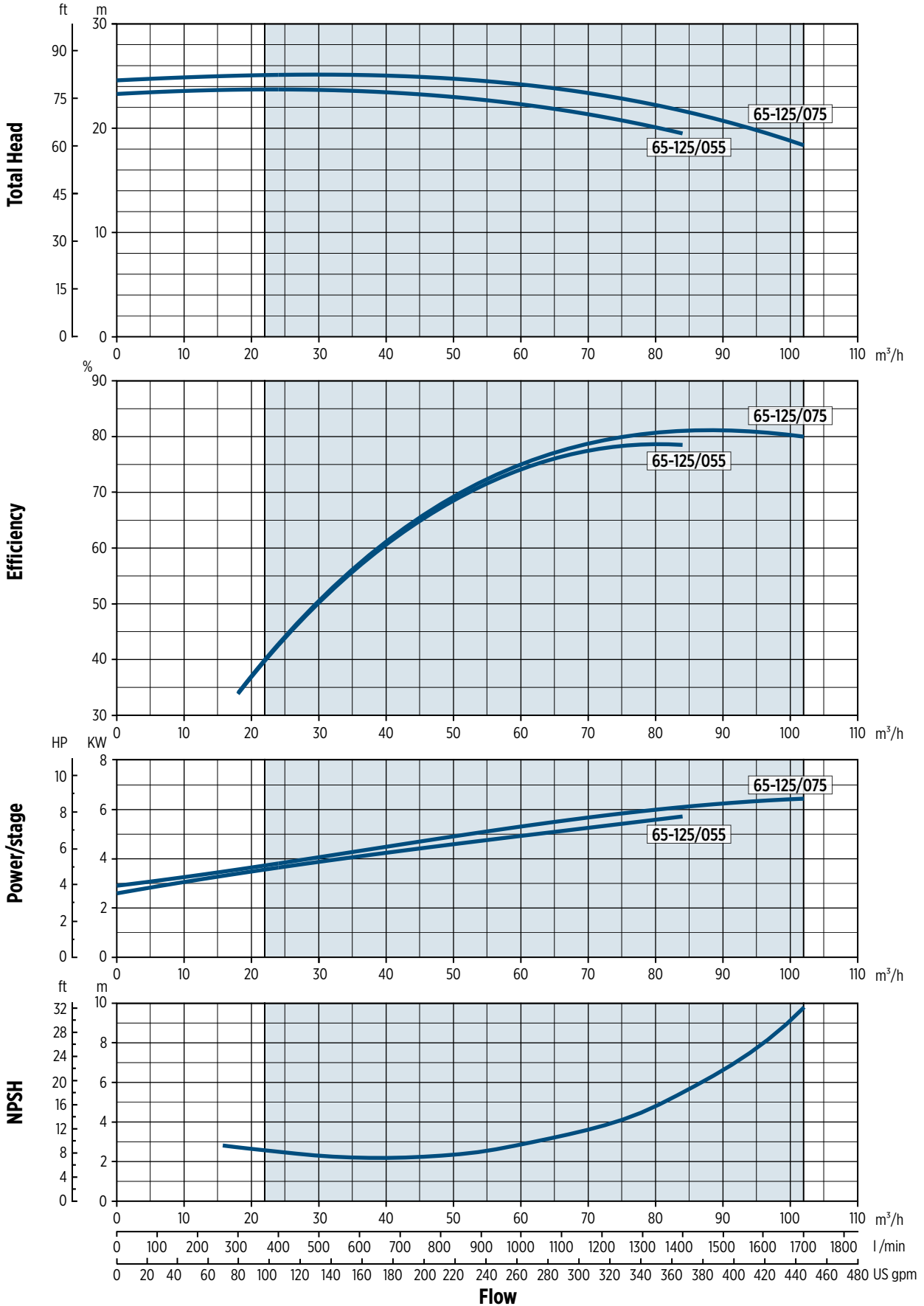

002024EN 03/2019

FNC/FNS/FNE 65-160 - PERFORMANCE CURVES

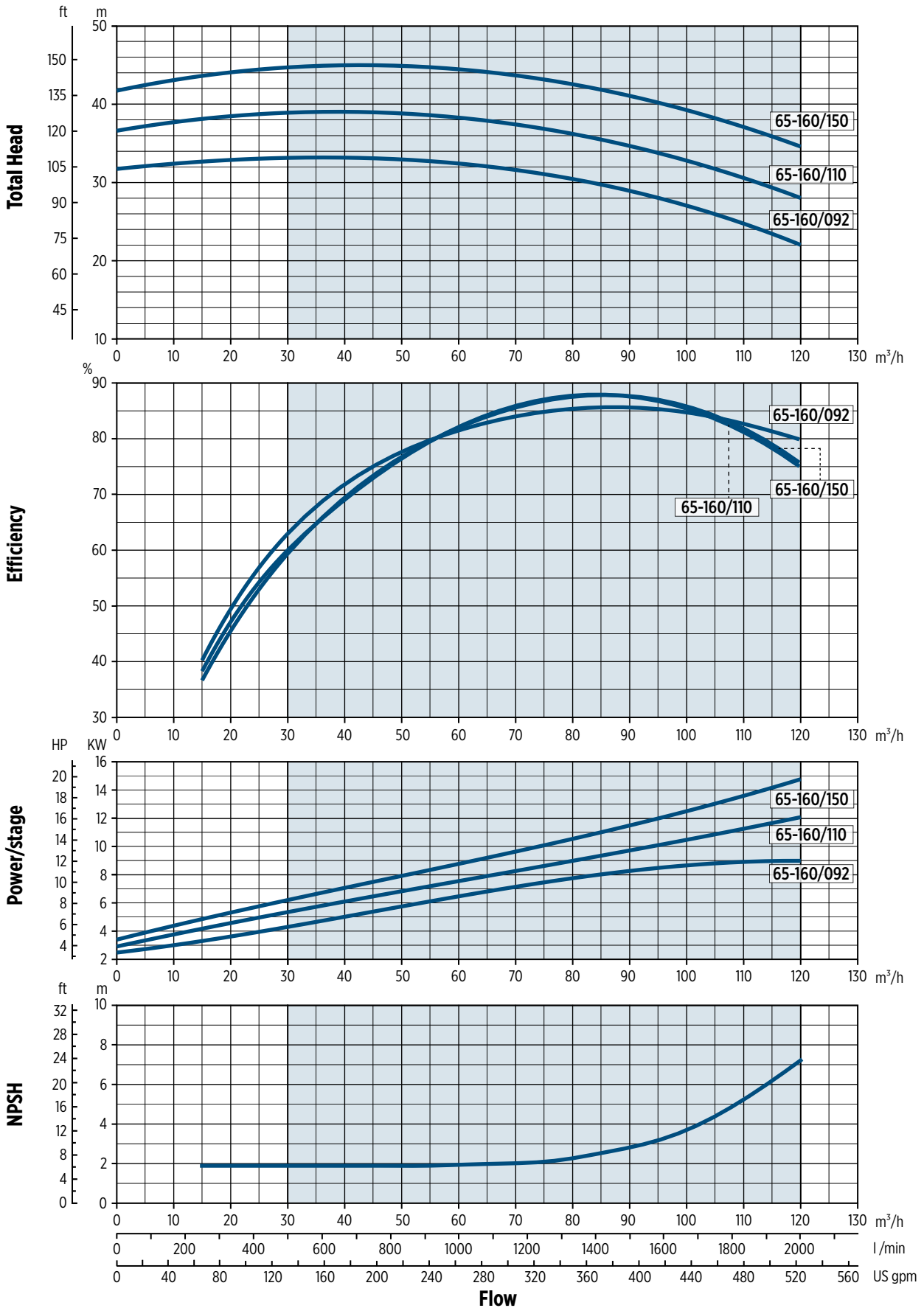

002025EN/05/2019

FNC/FNS/FNE 65-200 - PERFORMANCE CURVES

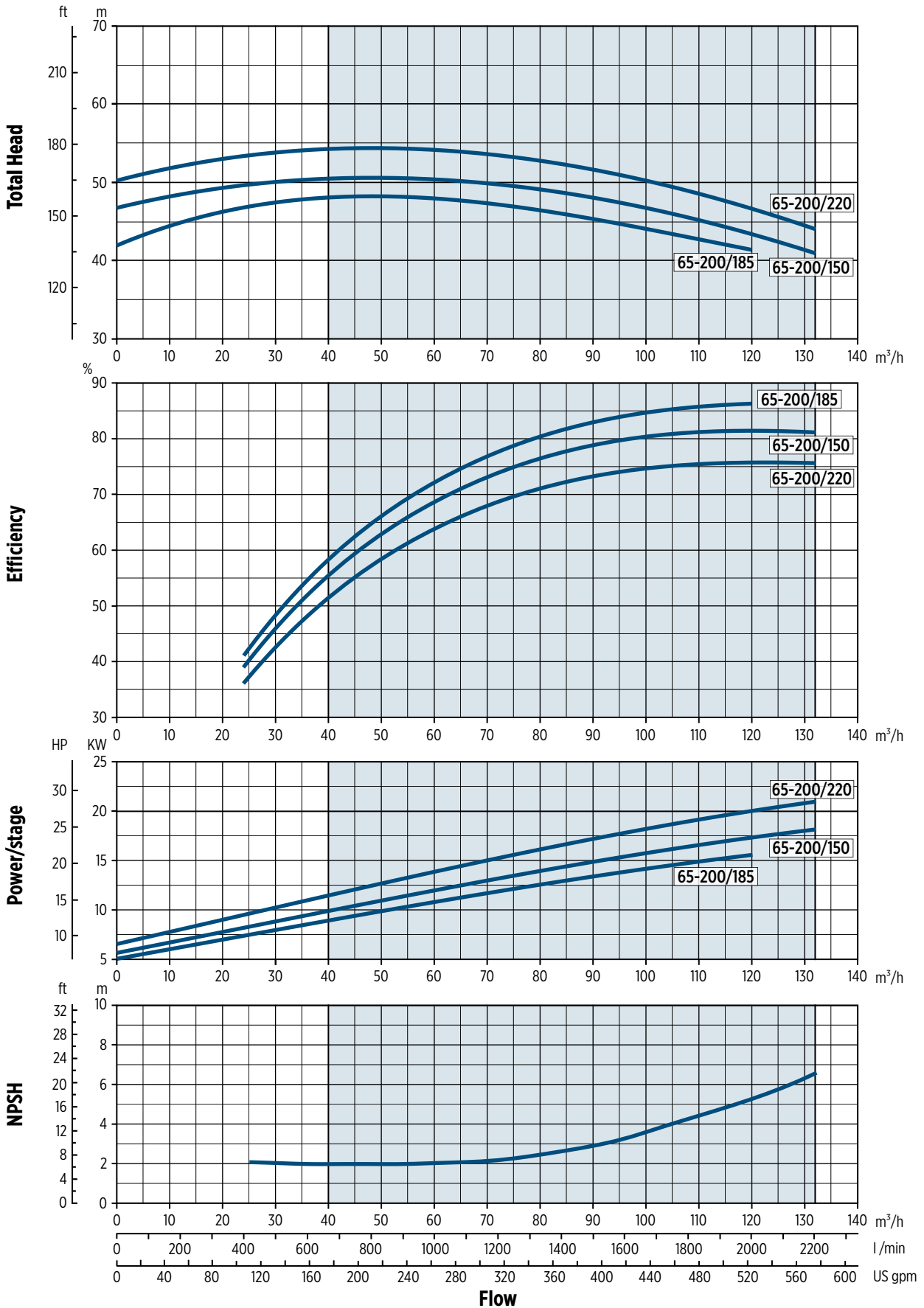

002026EN 03/2019



FNS/FNE 65-250 - PERFORMANCE CURVES

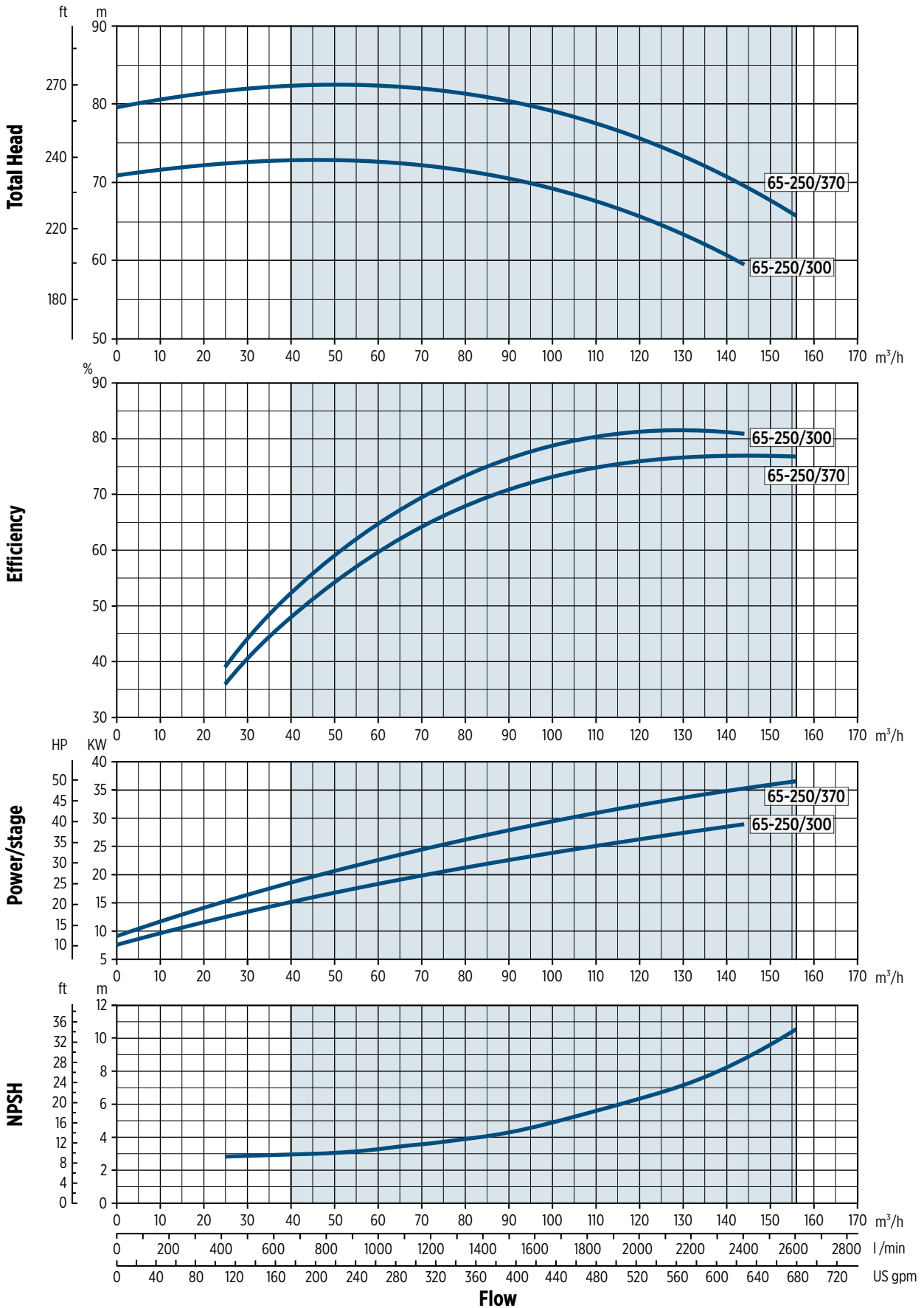

002027EN 05/2019

FNC/FNS/FNE 80-160 - PERFORMANCE CURVES

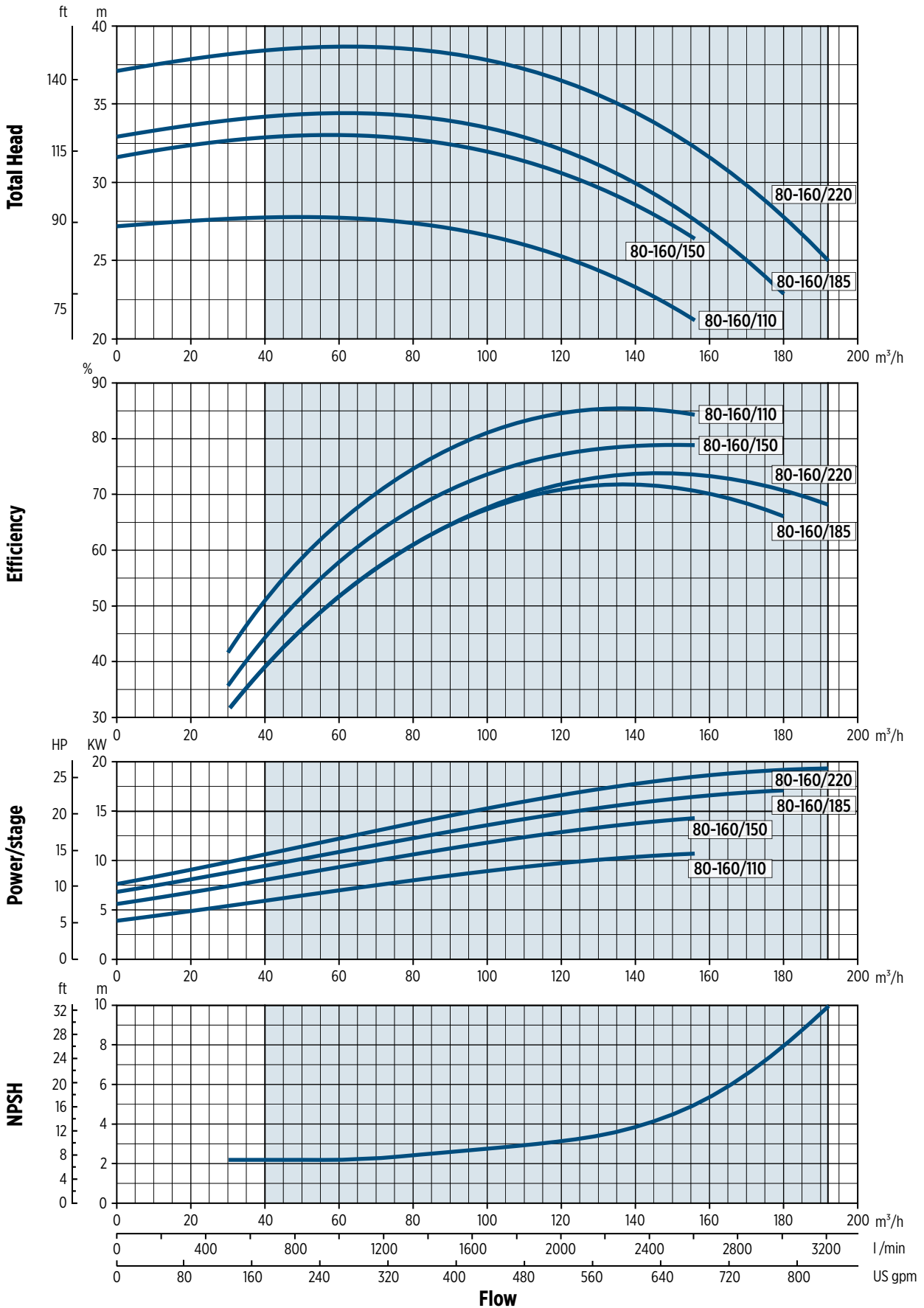

002028EN 03/2019



FNS/FNE 80-200 - PERFORMANCE CURVES

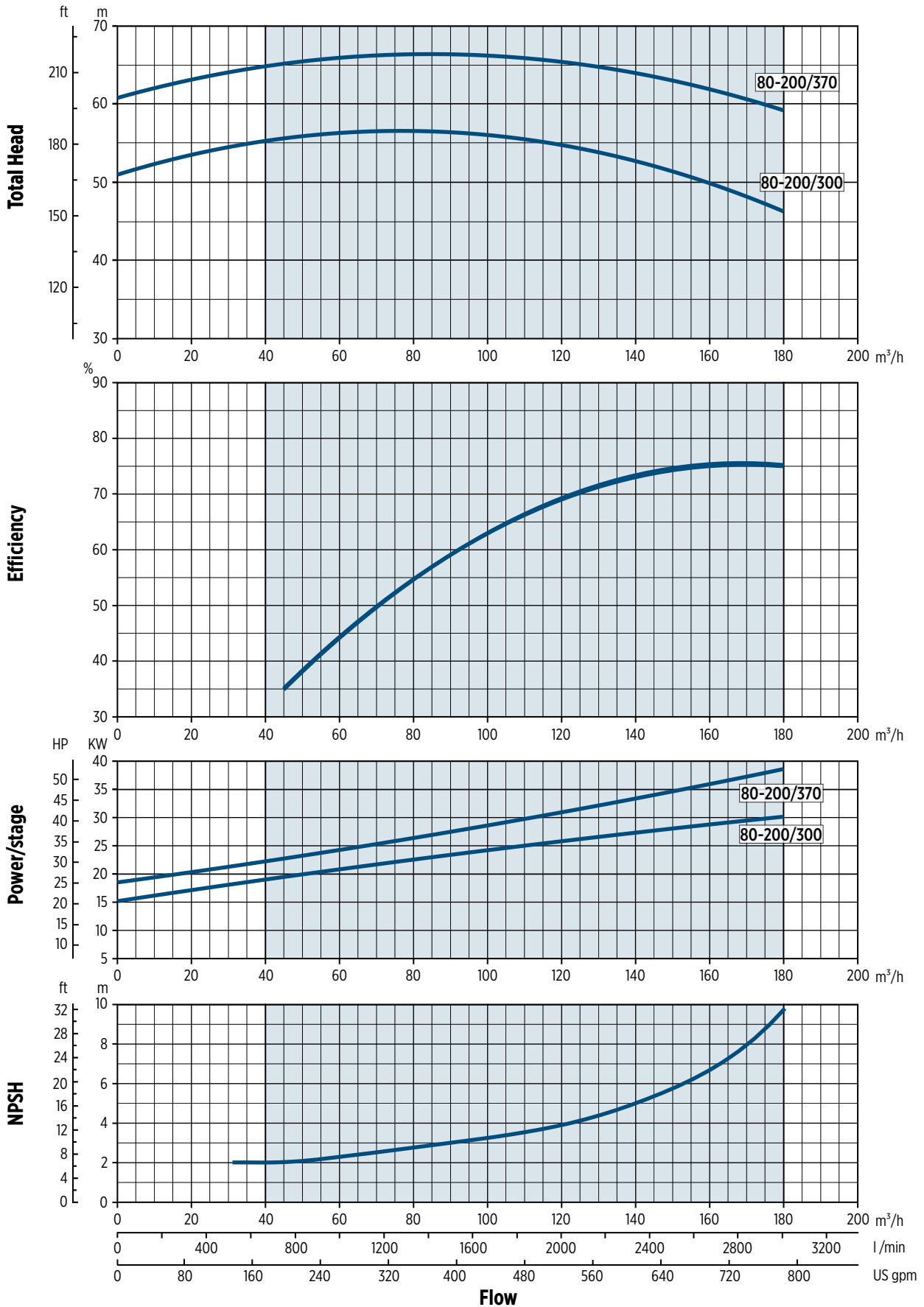

002029EN 03/2019

FNS/FNE 80-250 - PERFORMANCE CURVES

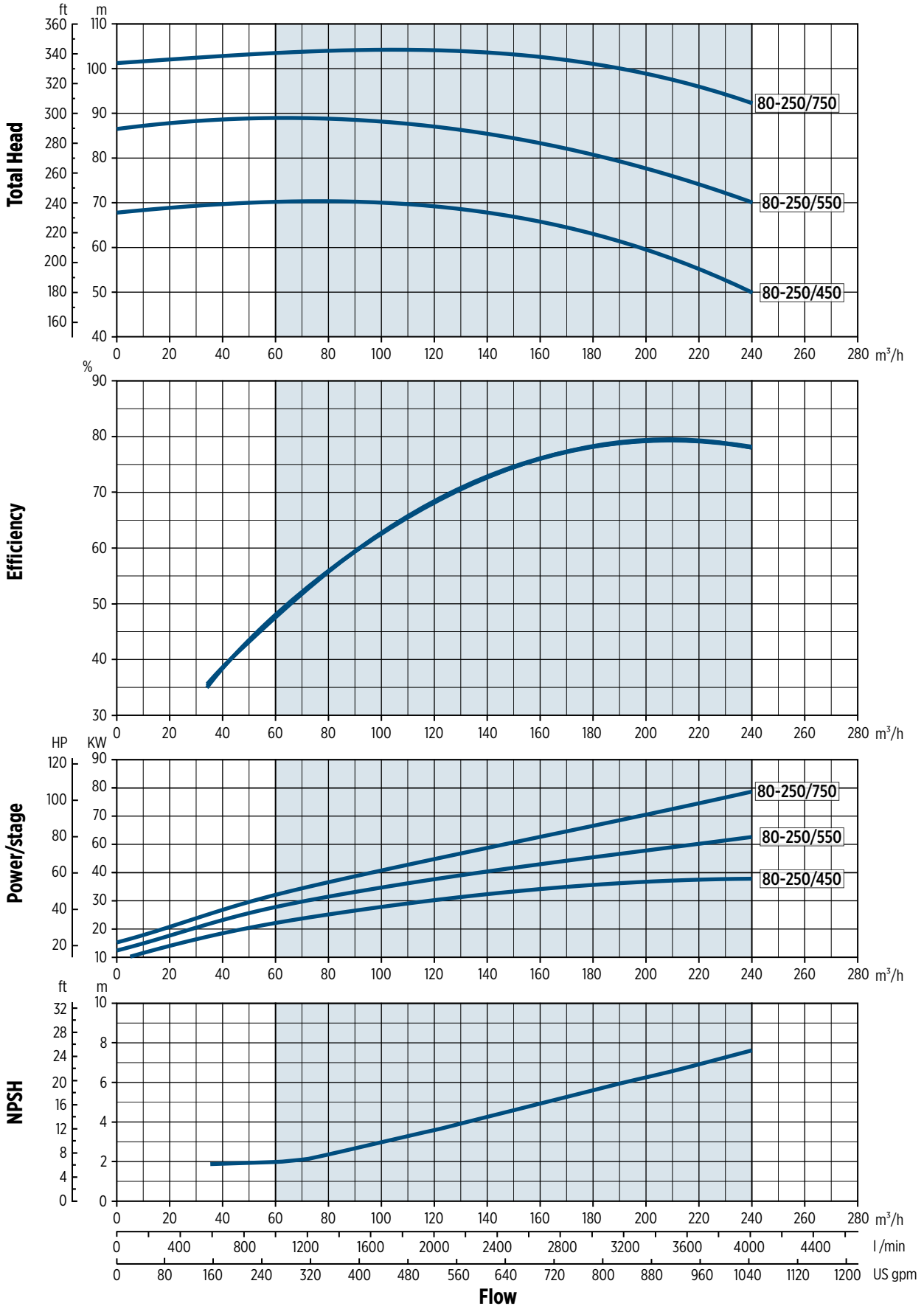

002022EN/05/2019





Franklin Electric

Franklin Electric S.r.l.
Via Asolo, 7 - 36031 Dueville (Vicenza) - ITALY
Phone: +39 0444 361114 - Fax: +39 0444 365247
Email: sales.it@fele.com

Single member - Company subject to the control and coordination of Franklin Electric Co., Inc.

Franklin Electric S.r.l. reserves the right to amend specification without prior notice

00105031_EN_REV00_03/2019

franklinwater.eu